

COMPUTER SEWING MACHINE

HZL-F series

INSTRUCTION MANUAL

**Attention**

Please read this instruction manual before using the machine as it contains important operational and safety information.

Keep this manual accessible so that you may refer to it at anytime while operating the machine.

IMPORTANT SAFETY INSTRUCTIONS

When using an electrical appliance, basic safety precautions should always be followed, including the following:
Read all instructions before using this sewing machine.

DANGER -To reduce the risk of electric shock:

1. An appliance should never be left unattended when plugged in.
2. Always unplug this appliance from the electric outlet immediately after using and before cleaning.

WARNING -To reduce the risk of burns, fire, electric shock, or injury to persons:

1. Do not allow this appliance to be used as a toy. Close attention is necessary when this appliance is used by or near children.
2. Use this appliance only for its intended use as described in this manual. Use only attachments recommended by the manufacturer as contained in this manual.
3. Never operate this appliance if it has a damaged cord or plug, if it is not working properly, if it has been dropped or damaged, or dropped into water. Return the appliance to the nearest authorized dealer or service center for examination, repair, electrical or mechanical adjustment.
4. Never operate the appliance with any air openings blocked. Keep ventilation openings of the sewing machine and foot controller free from the accumulation of lint, dust and loose cloth.
5. Keep fingers away from all moving parts. Special care is required around the sewing machine needle.
6. Always use the proper throat plate. The wrong plate can cause the needle to break.
7. Do not use bent needles.
8. Do not pull or push fabric while stitching. It may deflect the needle causing it to break.
9. Switch the sewing machine off ("O") when making any adjustments in the needle area, such as threading needle, changing needle, threading bobbin, or changing presser foot and the like.
10. Always unplug sewing machine from the electrical outlet when removing covers, lubricating, or when making any other user servicing adjustments mentioned in the instruction manual.
11. Never drop or insert any object into any opening.
12. Do not use outdoors.
13. Do not operate where aerosol (spray) products are being used or when oxygen is being administered.
14. To disconnect, turn all controls to the off ("O") position, then remove plug from outlet.
15. Do not unplug by pulling on cord. To unplug, grasp the plug, not the cord.

SAVE THESE INSTRUCTIONS

This sewing machine is intended for household use only.

Foot controller: Model JC-001 Foot controller can be used on sewing machine model HZL-F300, HZL-F400, or HZL-600.

The working temperature of sewing machine is from 5 to 40 degree Celsius. Do not use sewing machine under direct sunlight, near a heat source such as stove, iron, candle or any hot objects and in the place where temperature is high. Otherwise temperature inside sewing machine becomes high and/or vinyl of the power cord may be damaged, resulting in fire or an electric shock.

Always check a combination of material, thread and needle size. (Refer to page 24.) If the combination is not right, for example, sewing thick material such as denim with thin needle like size 11 and smaller, needle may break and it will cause injury to your body.

Thank you for purchasing our products.

To safely and properly use this product, please read the instruction manual carefully and understand the properties of this computer sewing machine. This machine is composed of well-chosen brand-name parts and is well quality controlled. Please try a variety of different sewing methods and have fun.

- Do not expose machine to direct sunlight or humid atmosphere.



- Do not use thinner or other similar solvents to clean machine.



As the microcomputer(s), semi-conductor(s) and precise wiring board(s) is built in this sewing machine, please pay attention that the following condition(s) may occur.

- Use this product in a temperature between 5 and 40 degree Celsius.
If temperature is extremely low, this sewing machine may not work properly.

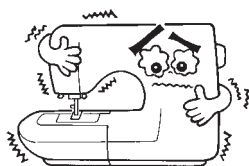

- This sewing machine will stop due to safety mechanism to prevent the machine from overheating, when it sews slowly and for a long time. In this event, Start and Stop button will not light.

The sewing machine will return to working condition after about 10 minutes.

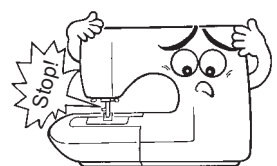

Contents

Important safety instructions	1, 2
Principal parts	5
Accessories	6

Basic operations

Function of operational buttons	7
Connecting to the power supply	8, 9
Name and function of other operational buttons	10, 11
Speed control	12
Presser foot lifting lever and installation of knee lifting lever	13
Changing the presser foot	14, 15
Bobbin thread preparation	16~19
Needle thread preparation	20~21
Threading the needle thread	
Automatic needle threader	
Pulling up the bobbin thread	
Attaching the needle	24
Fabric, thread and needle table	25
How to adjust thread tension	26
How to adjust presser foot pressure	27
How to lower feed dog	27
How to select a stitch pattern F600	28, 29
How to select a stitch pattern F400	30, 31
How to select a stitch pattern F300	32, 33

Practical sewing

Straight stitch	34~38
How to use seam guide line on the throat plate	
Automatic lock stitch and programmed thread trimming	
How to change needle positions	
How to change the stitch length	
Other straight stitch patterns	
Zigzag stitch	39
Overcasting stitch	40, 41
Blind stitch	42~44
Buttonhole stitches	45~50
Standard buttonholing	
Keyhole buttonholing	
Buttonhole with gimp	
When changing the width of the buttonhole	
When changing the density of the seam	
Manual 2-step buttonhole	51, 52
Bartacking	53, 54
Inserting zippers	55~57
Side zipper attachment	
Butted zipper attachment	
Shirring and gathering	58
Pintucking	59
Welt seam	60
How to use quilt guide F600 / F400	61
Scallop stitches	62
Decorative stitches	63

Patchwork quilt

Patchwork piecing (joining)	64
Applique (1)	65
Applique (2)	66
Crazy quilt	67
Stitch in ditch quilting F600 Only	68
Quilting (straight stitch) F600 / F400	69
Quilting (free motion) F600 / F400	70, 71

Decorative stitches

One-point stitch/sewing letters	72~79
Preparation before stitching	72
Test sewing	72
Operational buttons and screen	73
How to select patterns (letters)	74, 75
How to edit patterns (letters).....	76
How to stitch a pattern (letters)	77
Disposing thread ends of jump stitches	77
Save / call of pattern (letters)	78, 79
Character selecting methods	80

Type and usage of Options 	81~90
---	-------

1. Change of seam width of buttonhole
2. Change of needle position
3. Setting the thread trimming foot switch to OFF
4. Twin needle sewing
5. Guide
6. Contrast of liquid crystal display (LCD)
7. Button reception buzzer volume settings
8. Language setting
9. Elongation

Message catalog	91
Introduction of optional accessory parts	92, 93
How to install wide table	94
Machine maintenance	95
Performance check list	96, 97
List of stitch patterns F600	98, 99
List of stitch patterns F400	100, 101
List of stitch patterns F300	102, 103
Specifications	104

Principal parts

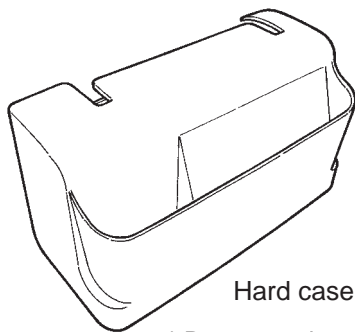
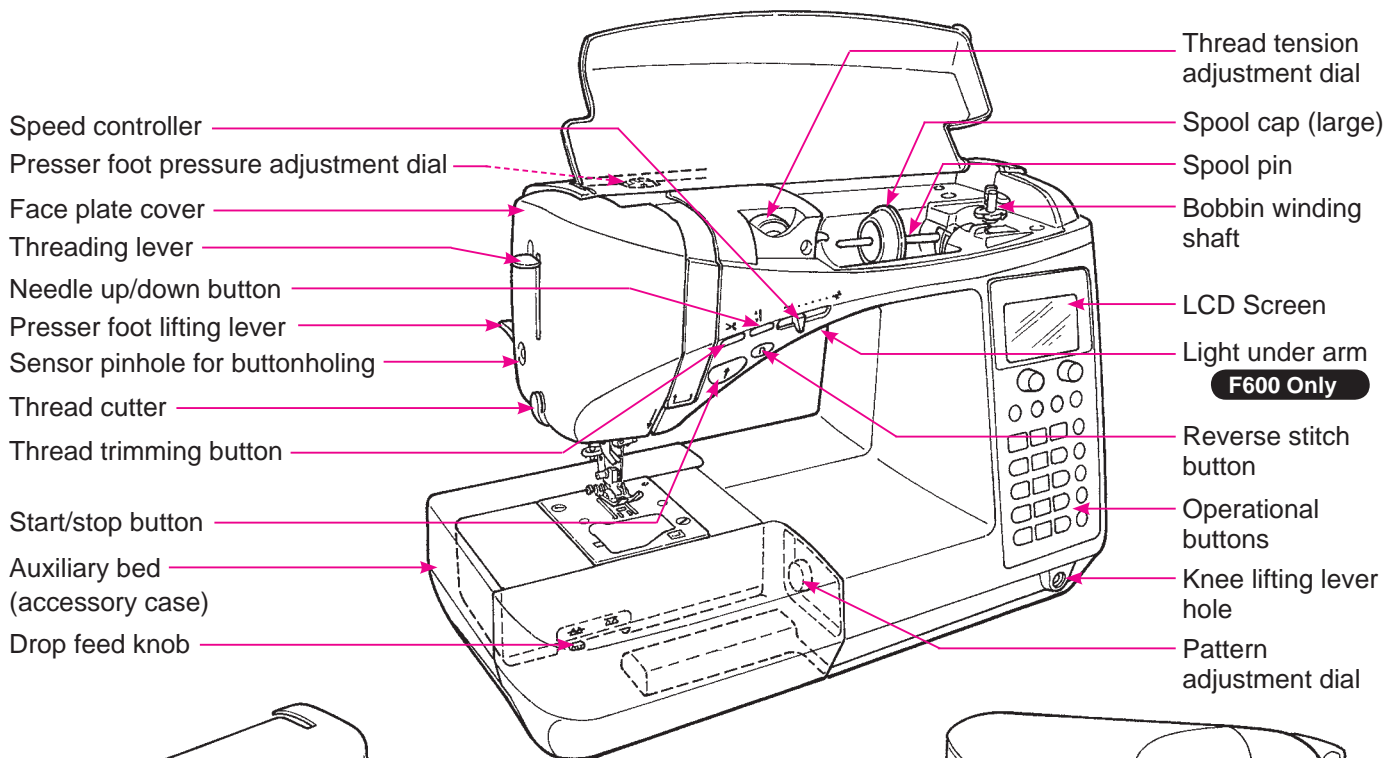

* Do not put heavy objects onto hard case and wide table.

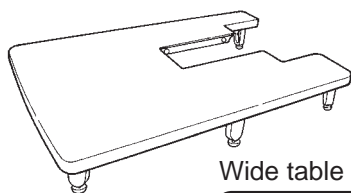

F600 Only

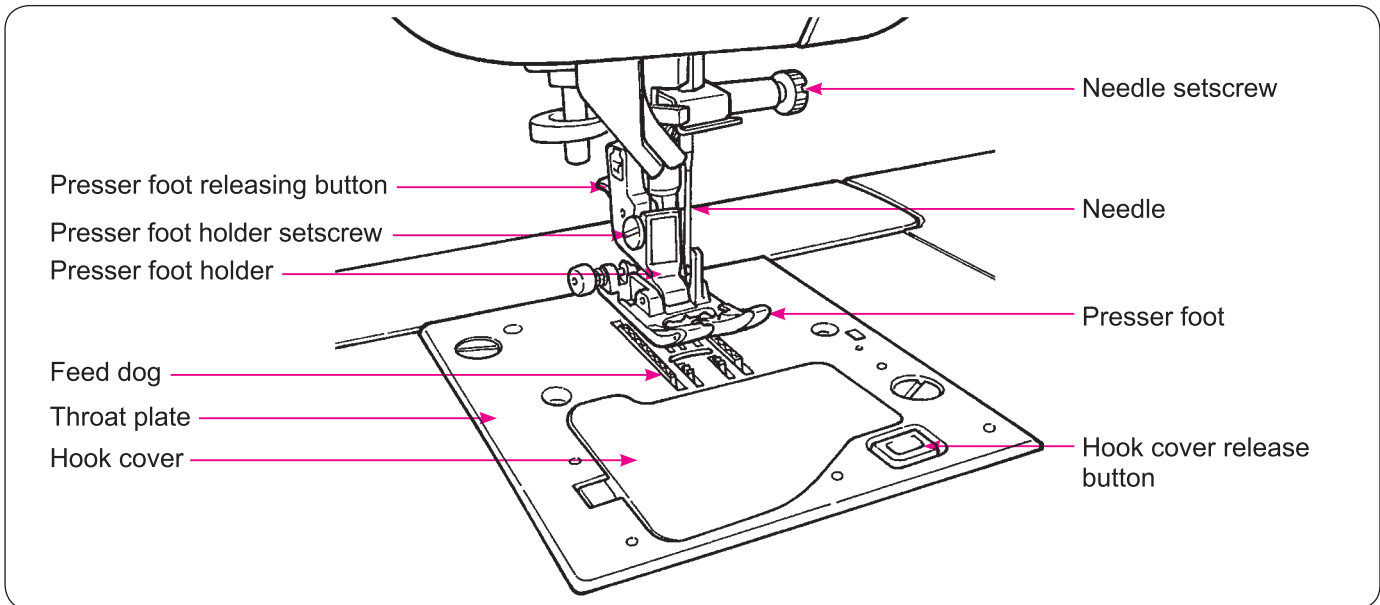
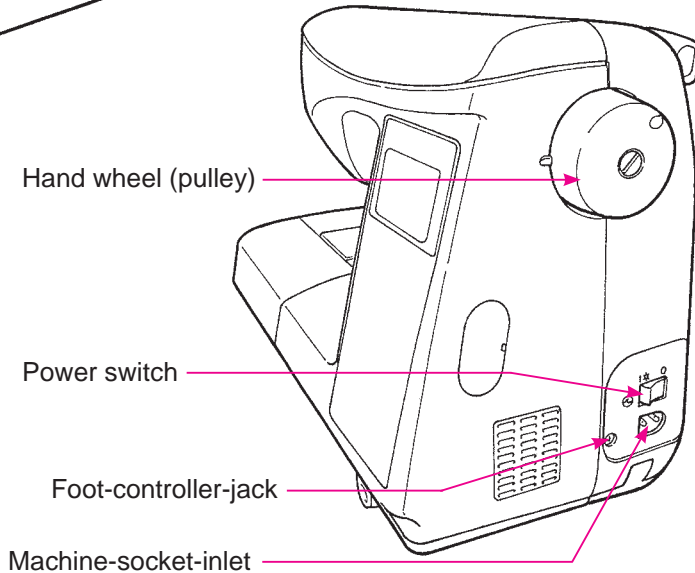

Accessories

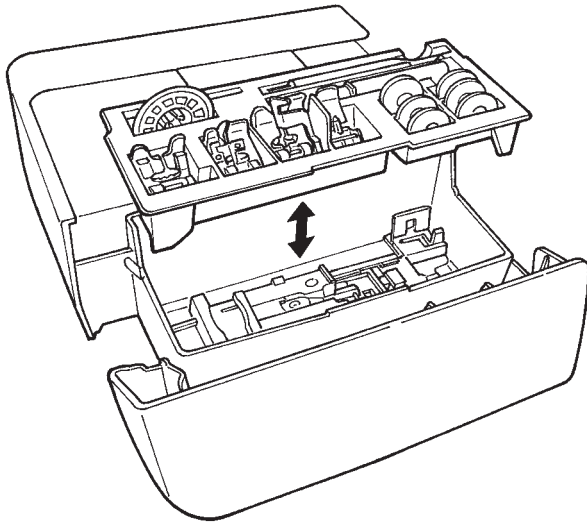

Draw the auxiliary bed out to the left.

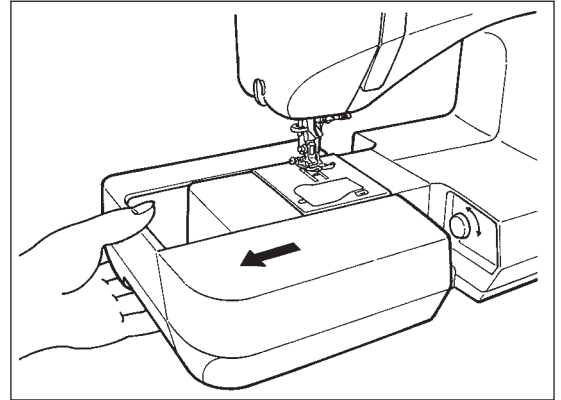

• Inside the auxiliary bed.

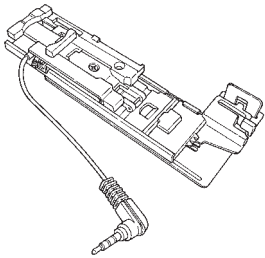

Buttonhole presser foot (E)

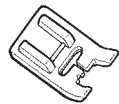

Manual buttonhole presser foot (I)

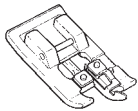

Overcasting presser foot (C)

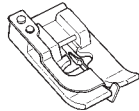

Blind stitch presser foot (D)

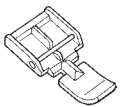

Zipper presser foot (B)

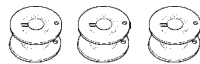

Bobbin (3)

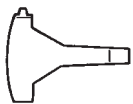

T-shape screwdriver



Ripper

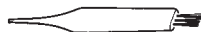

Cleaning brush

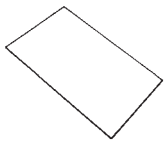

Needle set
HA X 1 # 11 (1)
14 (1)
16 (1)
for knit # 11 (1)



Spool cap (Small)



Spool cap (Middle)

• Supplied with the machine

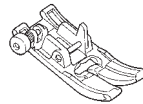

Standard presser foot (A)



Bobbin (1)

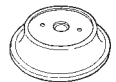

Spool cap (large)

• Inside the accessories bag.

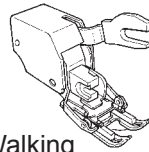

Walking foot (N)

F600 / F400

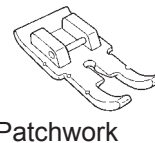

Patchwork presser foot (P)

F600 / F400



Auxiliary spool pin

F600 / F400

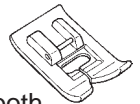

Smooth presser foot (T)

F600 Only

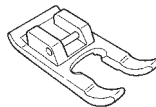

Open toe presser foot (O)

F600 Only



Quilt presser foot (Q)

F600 / F400

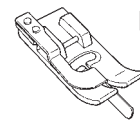

Edge Sewing presser foot (R)

F600 Only



Quilt guide

F600 / F400

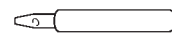

Eyelet punch

F600 Only

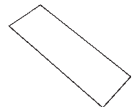

Twin needle

F600 / F400

• Inside hard case



Foot Controller
model name; JC-001

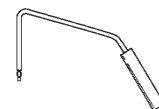

Knee-lifting lever

F600 / F400

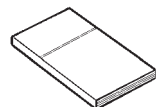

Instruction manual
(This manual)



Power cord

Function of operational buttons

Needle up/down button

When machine stops, press this button to change the needle position. (When the needle is up, the needle moves down and vice versa.)

* when a stitch pattern is not selected, needle does not move downward but you can move the needle up.



Even when the presser foot is raised, be aware that the needle moves up or downward.

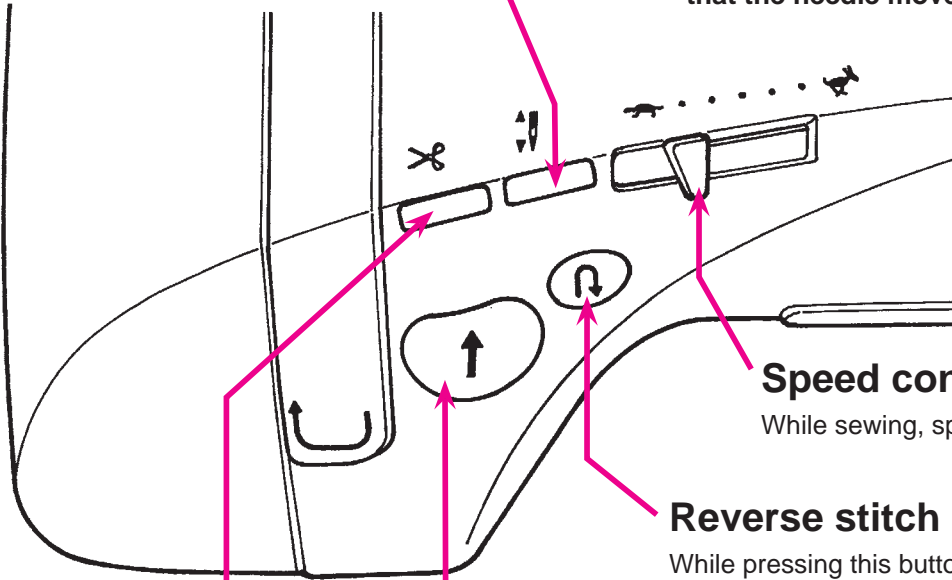

Speed controller

While sewing, speed can be adjusted.

Reverse stitch button

While pressing this button, machine sews reverse (lock stitch).

Start/stop button

When pressing this button, machine starts to sew slowly and then up to the speed set by speed controller.

When pressing this button again, machine stops with needle at its down position.

Color of button indicates machine status.

Green: Ready to start and/or while sewing

Red: Not ready to start (When it is pushed in red condition, needle moves by one stitch.)

Thread trimming button

After sewing, press this button to trim both threads automatically.

Notes for thread trimming:

1. Do not use thread thicker than No.30.
2. After trimming, the stitch can be done without pulling up bobbin thread.
3. When sewing again after thread trimming, if you pull up the bobbin thread again and place it underneath the presser foot together with needle thread, you can avoid birds nest on the wrong side of the fabric.
4. Regularly clean the machine (refer to page 94), as dust in the area of the thread trimming unit may cause malfunction.

Connecting to the power supply

■ Connecting to the power supply

Warning

- Disconnect the plug and turn off the power switch (turn to "O") that always sewing machine is not to use.

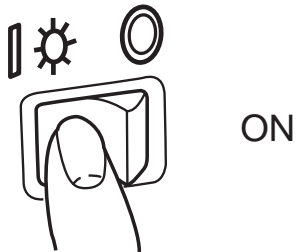
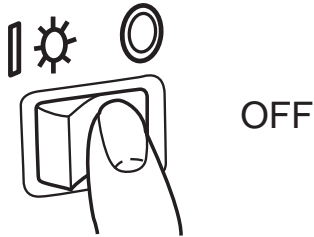

★ Operating power switch:

- Turn OFF the machine, set the power switch to "O"
- Turn ON the machine, set the power switch to "I"

WARNING (For U.S.A., Canada only)

This appliance has a polarized plug (one blade wider than the other). To reduce the risk of electric shock, this plug is intended to fit in a polarized outlet only one way. If the plug does not fit fully in the outlet, reverse the plug. If it still does not fit, contact a qualified electrician to install the proper outlet. Do not modify the plug in any way.

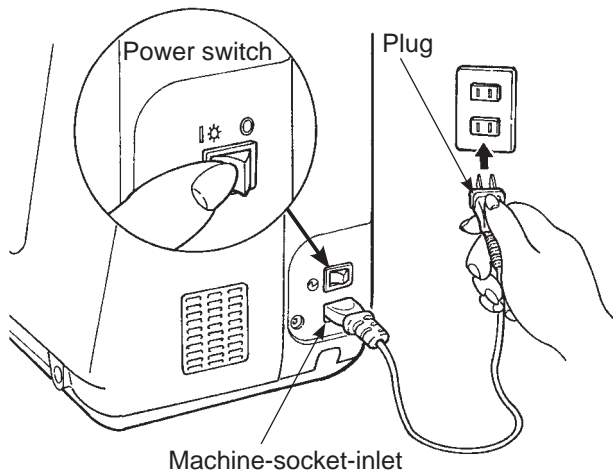

★ In case Start/stop button is used:

1. Turn OFF the power switch (turn to "O")
2. Insert cord-connector into machine-socket-inlet.
3. Insert plug into socket-outlet.
4. Turn ON the power switch. (Turn to "I")

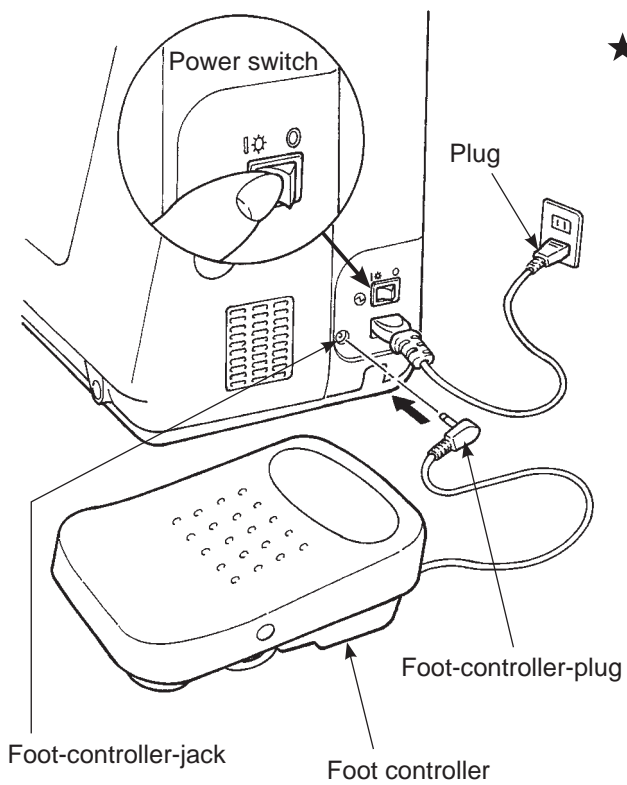

★ Using the foot-controller:

1. Turn OFF the power switch (turn to "O")
2. Insert the foot-controller-plug into the foot-controller-jack.
3. Insert cord-connector into machine-socket-inlet.
4. Insert plug into socket-outlet.
5. Turn ON the power switch. (Turn to "I")

* When the foot controller is plugged in, the start/stop button cannot be used to start sewing.

Start button: Can not operate to start sewing.

Stop button: Can operate to stop sewing.

Name and function of other operational buttons

Operational buttons and screen

Description of screen

	00 Direct patterns
	00 Practical patterns
	00 Buttonhole patterns
	00 Quilt patterns
	00 Decorative patterns
	00 One-point patterns
	Aa Letters

Presser foot to be used (marking)

Needle position
(Center needle position in this pattern.)

Zigzag width

Needle stop position

	Needle stops at its highest position
	Needle stops at its lowest position

Stitch pattern

* Patterns on the screen will be sewn.

Pattern select mode

	Direct select
	Select by number
	Cell phone input

Stitch length

1 Zigzag width adjusting dial

* Adjusting buttons on F400/F300.

4 Selection button

5 Clear button

13 Pattern selection mode switching button

	10 most often used patterns can be selected.
	Practical patterns other than direct patterns can be selected.
	Patterns such as letters which can be combined, can be selected.

12 Pattern selection button

Direct pattern

Number selection (Input by number)

Letters (Cell phone input)

2 Stitch length adjusting dial

* Adjusting buttons on F400/F300.

3 Confirmation button

6 Automatic lock stitch and thread trimming button

7 Needle stop position switching button

8 Continuous stitch button











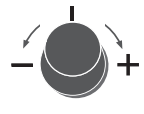
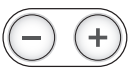
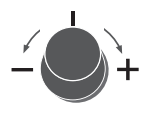
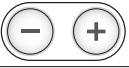







9 Mirror image button

10 Option button

11 Save/Call button

Name of operational button

■ Name and function of operational buttons

- | | | | |
|----|---|---|--|
| 1 |  | Zigzag width adjustment dial
* buttons on F400/F300.  | This is used to change the zigzag width and the needle position. |
| 2 |  | Stitch length adjustment dial
* buttons on F400/F300.  | This is used to change the stitch length. |
| 3 |  | Confirmation button | This is used to confirm the selected stitch pattern and/or settings. |
| 4 |  | Selection button | This is used to move the cursor. |
| 5 |  | Clear button | This is used to delete the selected stitch pattern and to cancel each setting. When pressing the button continuously, all the saved stitch patterns will be deleted. |
| 6 |  | Automatic lock stitch and thread trimming button | When it is pressed, symbol “  ” will be shown on the screen. The machine will automatically lock stitches at sewing-start and sewing-end and then trim both threads. |
| 7 |  | Needle stop position switching button | When it is pressed, either symbol “  ” or “  ” will be shown on the screen. When sewing with symbol “  ”, the needle stops at its highest position. When sewing with the symbol “  ”, the needle stops at its lowest position. |
| 8 |  | Continuous stitch button | This button is valid only when “  ” mode. When it is pressed, symbol “  ” will be shown on the screen. The machine will sew the selected stitch patterns continuously. When it is pressed again, the machine will cancel this function.
* When it is pressed while sewing, the machine will stop after the selected patterns are sewn completely. |
| 9 |  | Mirror Image button | After selecting a stitch pattern, press this button to make a mirror image of the selected pattern.
* There are some patterns that can not make a mirror image. |
| 10 |  | Option button | It is possible to change the following function and settings. <ul style="list-style-type: none"> • Seam width of buttonhole • Needle position • Thread trimming by foot controller • Twin needle • Guide • LCD display contrast • Buzzer volume • Language • Elongation * Optional functions vary from stitch pattern to stitch pattern. (Refer page 80~89 for more details.) |
| 11 |  | Save/call button | This is used to save and/or call a pattern. The machine can save maximum 10 patterns. (Refer to page 77 and 78 for more details.) |
| 12 |  | Pattern selection button | A stitch pattern can be selected.
* Usage of the buttons varies by pattern selecting mode. (Refer to page 27~32 for more details.) |
| 13 |  | Pattern selection mode switching button | When the pattern selection mode needs to be changed, press the desired button. The selected button will be illuminated. |

Speed control

■ Speed control

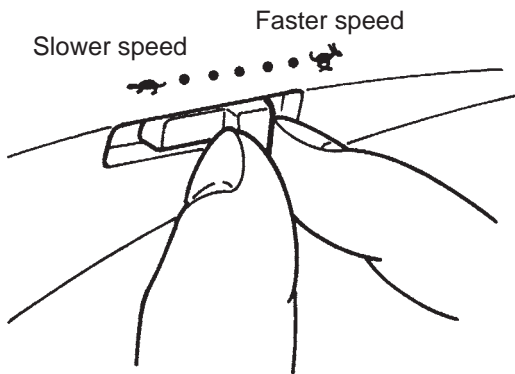

★ Speed controller

Maximum sewing speed can be freely set by the speed controller.

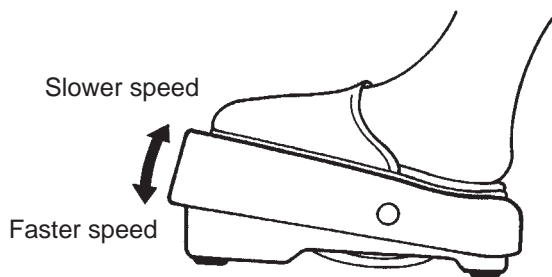

★ Foot controller

To run the machine, press the foot controller.
The harder you press, the faster the machine sews.
Speed controller will set the maximum sewing speed.

Pressing harder → faster speed

Pressing weaker → slower speed

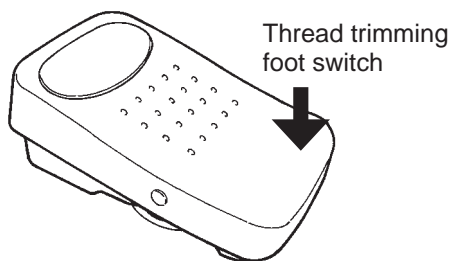

“Thread trimming foot switch”

When the heel side of the foot controller is pressed, the threads are trimmed.

→ It is also possible to cancel this function.

(Refer to page 82.)

* Always clean the foot controller.

It is important that you do not place any objects on the foot controller as it may cause injury to the user and may cause malfunctions.

Presser foot lifting lever and installation of knee lifting lever

■ Presser foot lifting lever

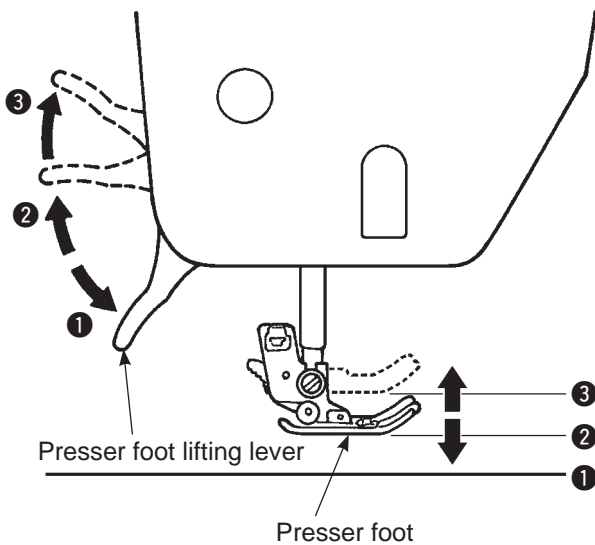

The presser foot can be up or down position by using the presser foot lifting lever.

- ① Lowered position Presser foot should be lowered when sewing.
- ② Ordinary lift position This position is used for fabric removal and/or changing the presser foot.
- ③ Extra lift position This position is used to put heavy materials underneath the presser foot.

* Be careful that the presser foot and the needle should not interfere when the needle is in down position and the presser foot is raised to the extra lift position.

■ Installation of knee lifting lever **F600 / F400**

The knee lifting lever is useful when a quilt is being sewn and for other projects that require the use of both hands. With the knee lifting lever, you are able to control the position of the presser foot without using your hands.

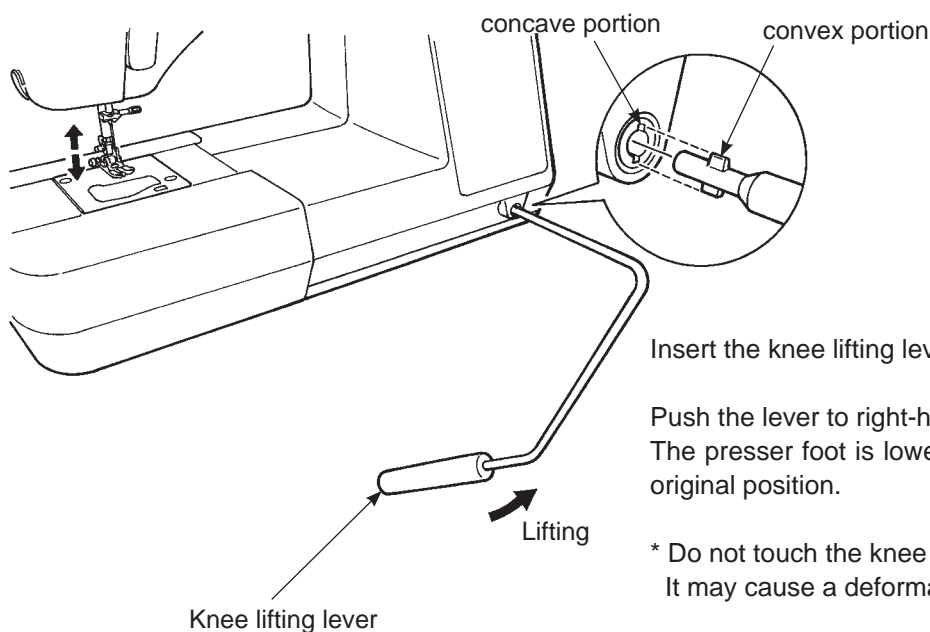

Insert the knee lifting lever so that concave and convex meet.

Push the lever to right-hand side to lift the presser foot. The presser foot is lowered when the lever goes back to the original position.

* Do not touch the knee lifting lever while sewing. It may cause a deformation of a stitch pattern.

Changing the presser foot

■ Removing and installing the presser foot

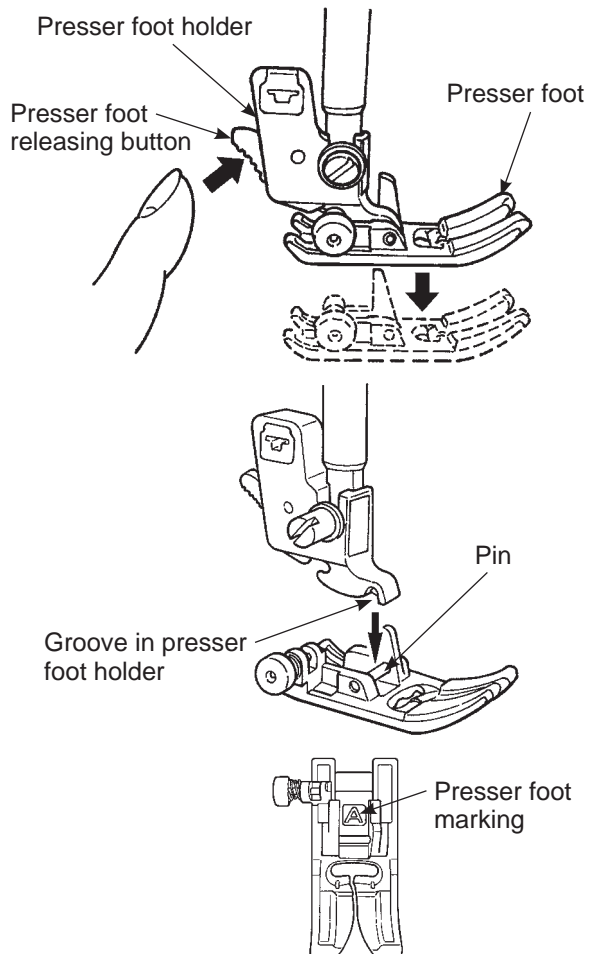

Attention

Turn OFF the power switch before replacing presser foot.

★ Removing presser foot

1. Raise the needle and presser foot.
2. Press the presser foot releasing button to remove the presser foot.

★ Installing presser foot

Align the pin of the presser foot and the groove in the presser foot holder. Then lower the presser foot holder with the presser foot lifting lever.

* Each presser foot has a marking. Use the appropriate presser foot for the stitch pattern to be sewn.

■ Removing and installing presser foot holder

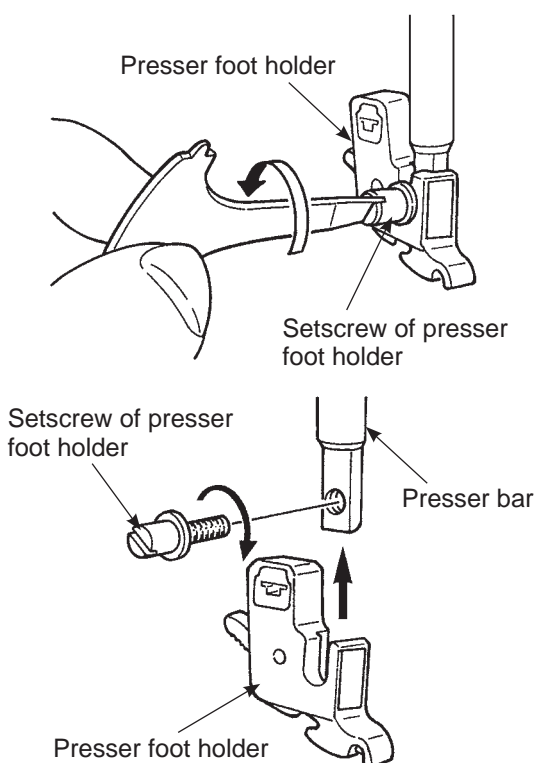

★ Removing presser foot holder

1. Lift the needle and presser foot lifting lever.
2. Loosen the setscrew of the presser foot holder to the left and remove the presser foot holder.



★ Installing presser foot holder

Align the screw hole at the presser bar with the hole of presser foot holder (long groove). Tighten the setscrew firmly by turning it to the right side.

■ The type and application of the presser foot

Marking of presser foot

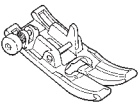
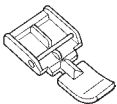
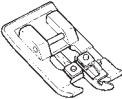
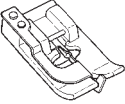
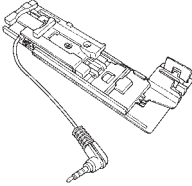

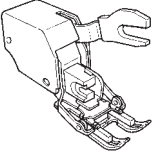
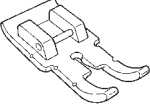
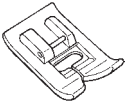
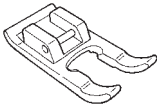
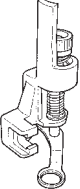
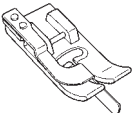
	Standard presser foot	A	This is used mainly for straight stitch and zigzag stitches. Use this presser foot especially when sewing heavy-weight materials.
	Zipper presser foot	B	This is used to attach zippers.
	Overcasting presser foot	C	This presser foot is used exclusively for overcasting to prevent the cut edge of fabrics from fraying.
	Blind stitch presser foot	D	This presser foot is used for blind stitch on hems of trousers and skirts, or sleeves.
	Buttonhole presser foot	E	This presser foot is used for automatic buttonholing.
	Manual buttonhole presser foot	I	This is used for sewing decorative stitches, letters and bartacks. Also for manual buttonhole (pattern No. 03).
	Walking foot F600 / F400	N	In general, this presser foot is used for difficult-to-feed* materials such as knits, jersies, vinyl, artificial leather and leather or quilting.
	Patchwork presser foot F600 / F400	P	This presser foot is used for patchwork stitches. There are two seam lines, 1/4-inch and 1/8-inch from center needle position.
	Smooth presser foot F600 Only	T	This presser foot is used for non-slippery materials like vinyl and satin stitches.
	Open toe presser foot F600 Only	O	This is used for the applique and decorative stitches. (Front part of the presser foot is open for better visibility.)
	Quilt presser foot F600 / F400	Q	This is used for the quilt stitch. (Machine setting: Straight Stitch and Center needle position)
	Edge Sewing presser foot F600 Only	R	This is used for patchwork, sewing center line of joined materials by using the center guide of the presser foot. * Fine tune the needle position by zigzag width adjustment dial.

Bobbin thread preparation

■ Taking out the bobbin

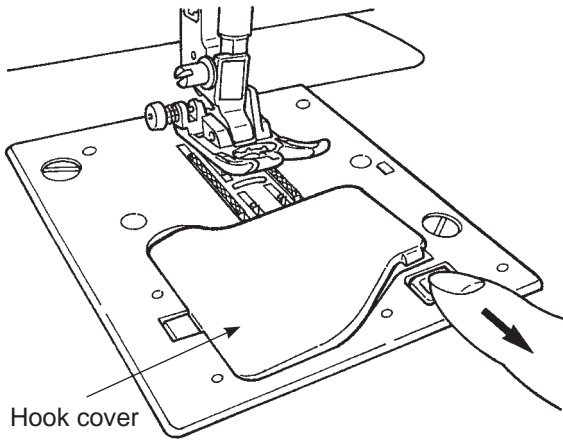

1 Open the hook cover.

Attention

Turn OFF the power switch before the bobbin is taking out and/or put into the bobbin case.

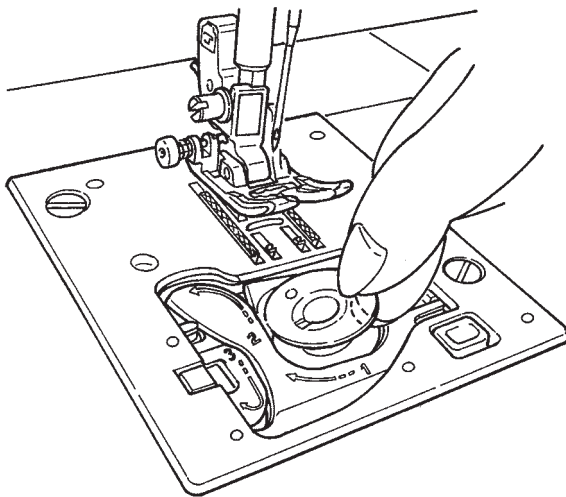

2 Take out the bobbin.

- * If the bobbin has too little thread, do not use it as the thread will get tangled.
- * Use only the designated bobbin. Other bobbins may cause malfunction.

■ Setting thread spool

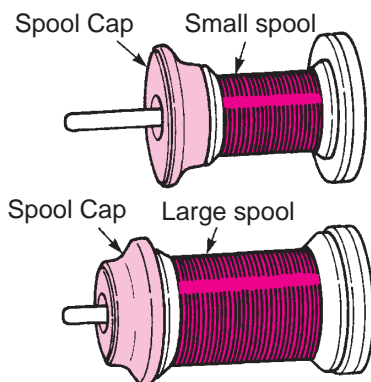

1 Place a thread spool to spool pin and a spool cap onto the spool pin.

- * Do not use the thread cone with a small amount of thread. This may cause thread tangling and/or the thread coming out of the eye of the needle when starting to sew.

There are three types of the spool caps, large, medium and small. Choose the size of spool cap according to the thread spool to be used.

■ Winding the bobbin thread

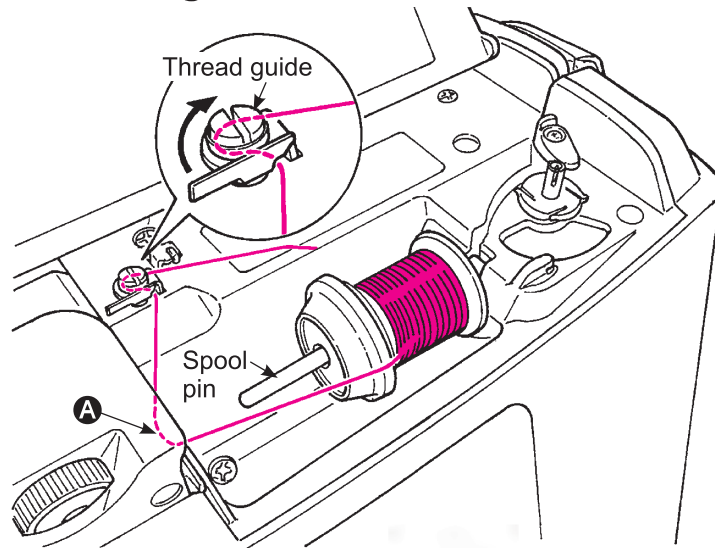

* An exclusive motor is built-in for winding bobbin so that you can wind bobbin at any time.

1 Place the thread spool to the spool pin.

2 Thread the guide **A** and then thread the thread guide (guide in the circle) for bobbin winding

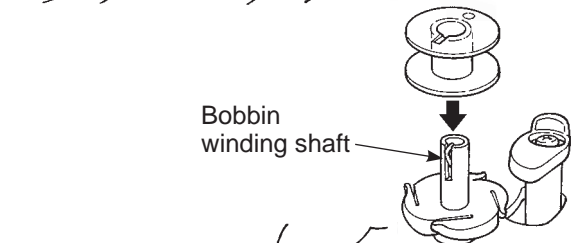

3 Set the bobbin on the bobbin winding shaft.

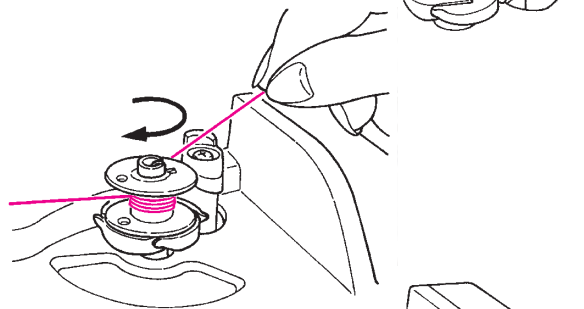

4 Wind the thread to the bobbin 4-5 times in clockwise direction.

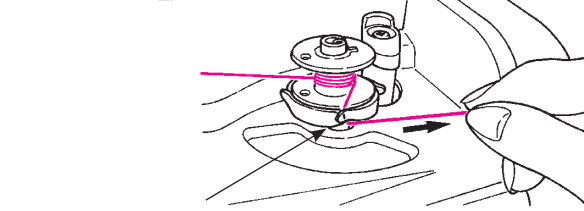

5 Put the thread end into the guide at the bobbin winding shaft and pull it to the right side to cut it.

Guide (with cutter)

6 Push the bobbin winding regulator towards the bobbin to start winding the bobbin.

* Be careful that the bobbin winding regulator works as a switch.

Bobbin winding regulator

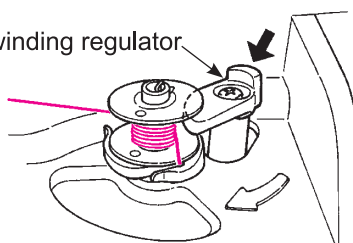

7 When winding is finished, the shaft stops automatically, the bobbin winding regulator moves to right and return to the original position.

Remove the bobbin from the bobbin winding shaft and cut the thread by cutter.

* Bobbin winding will automatically stop even while winding, when the winding speed is reduced due to a load to the bobbin winding motor caused by thread tangling.

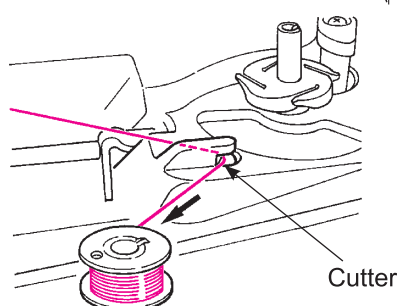

Cutter

■ Setting the bobbin

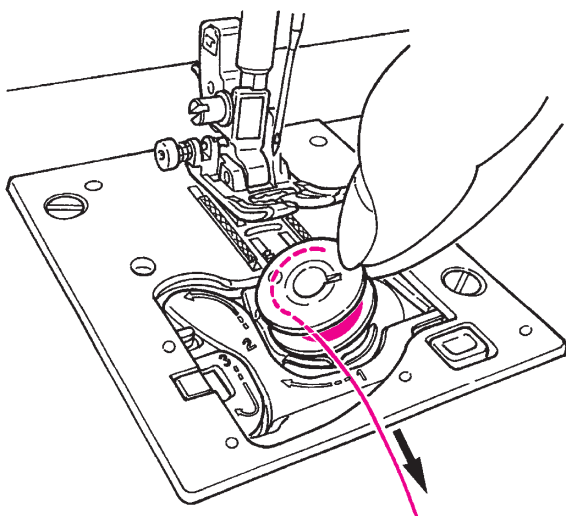

1 Put the bobbin in the bobbin case.

* Place the bobbin so that thread winds counterclockwise.

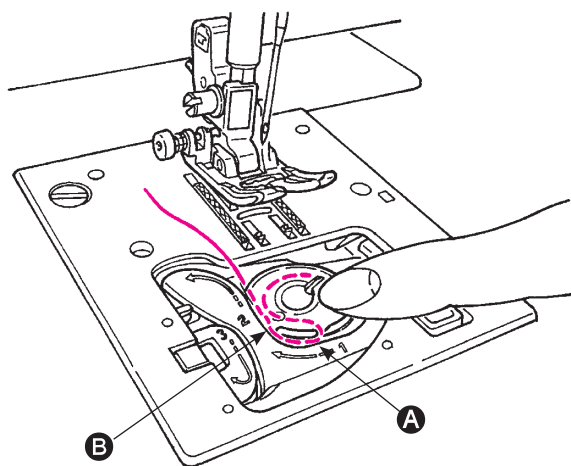

2 Thread groove **A** and **B** by pulling the thread end.

* It will be easier to thread grooves when you press the bobbin lightly with your finger.

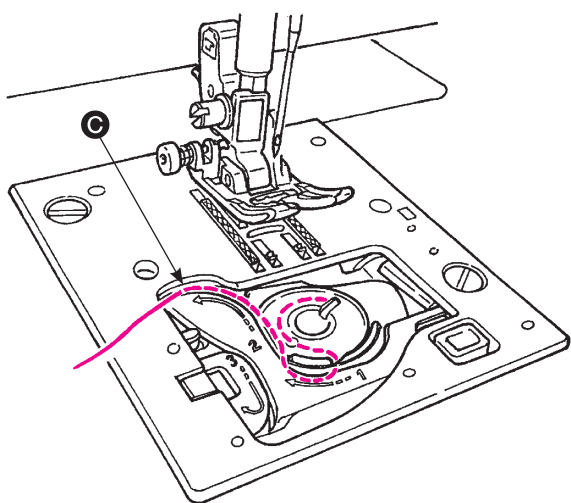

3 Thread guide **C** by pulling the thread to left side.

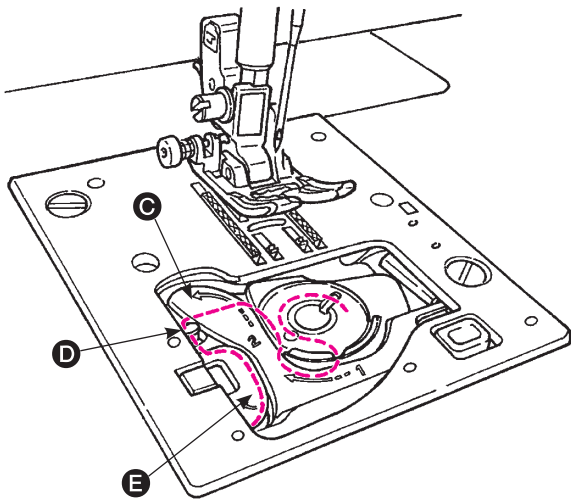

4 Thread to guide **D** and **E** leave the thread underneath. (Thread guide **E** first and it will thread to guide **D** as well.)

* When pulling bobbin thread, bobbin rotates counterclockwise. If bobbin rotates clockwise, put the bobbin upside down.

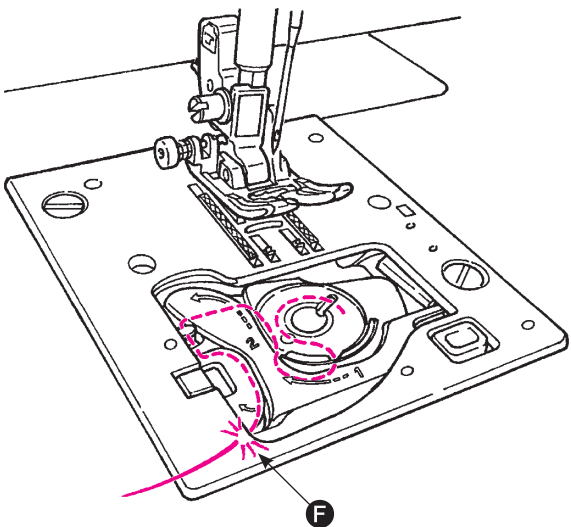

5 Cut the thread with the built-in cutter **F**.

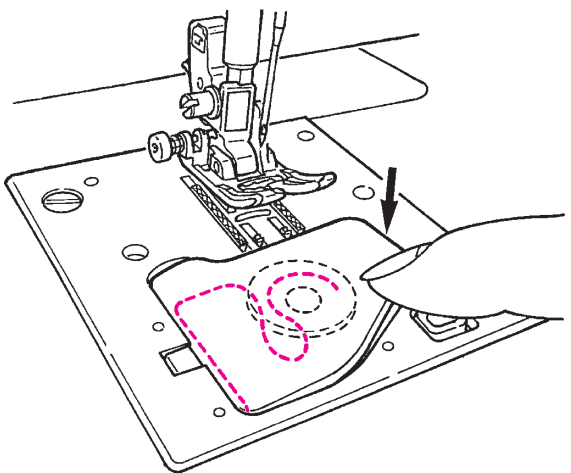

6 Close the hook cover.

You can start to sew in this condition (without pulling up the bobbin thread), however, if you want to sew with the bobbin thread pulled out, refer to “Pulling up the bobbin thread” in the page 22.

Needle thread preparation

Attention Turn OFF the power switch before winding the bobbin thread.

Threading the needle thread

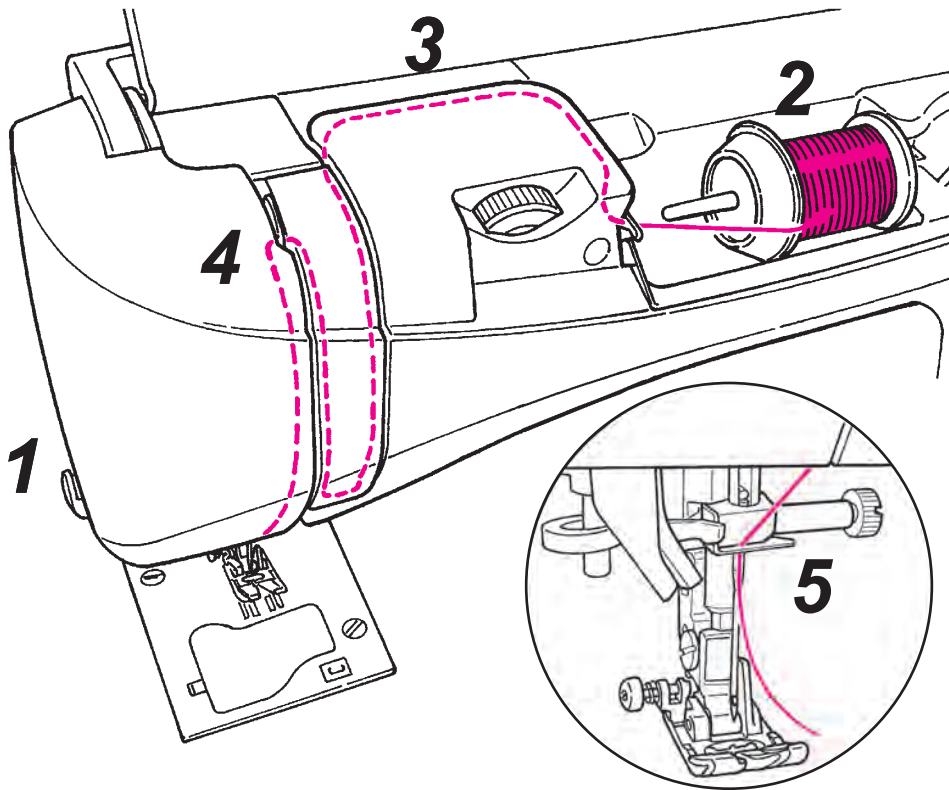

Note:

Make sure to push the needle to the top.

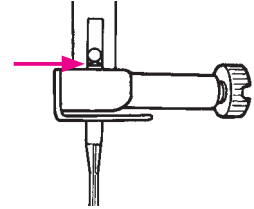

It is impossible to perform stitching if the needle is not correctly installed or a bent needle is used. Pay close attention as this will cause machine malfunction.

- * Use the needle: No.11-16 and the thread: No.30-90.
- * When twin needle is used, the automatic needle threader can not be used.

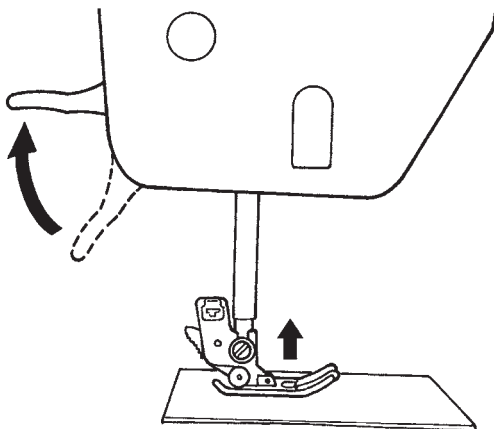

* Align the marking at the hand wheel with the one on the machine body.

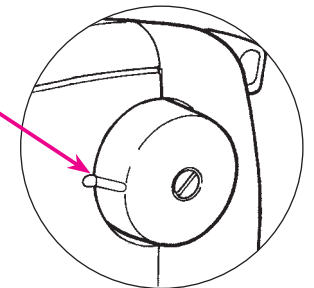

1 Lift the presser foot lifting lever.

2 Place a thread spool to the spool pin and a spool cap onto the spool pin.

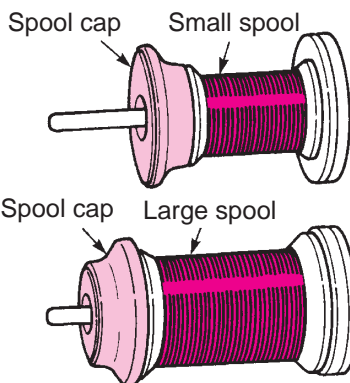

There are three types of the spool caps, large, medium and small. Choose the size of spool cap according to thread spool to be used.

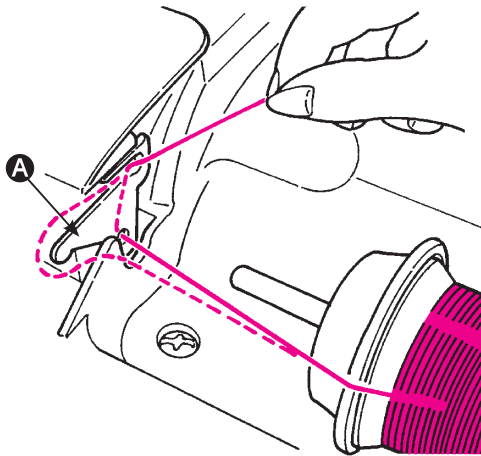

3 Thread to guide **A**.

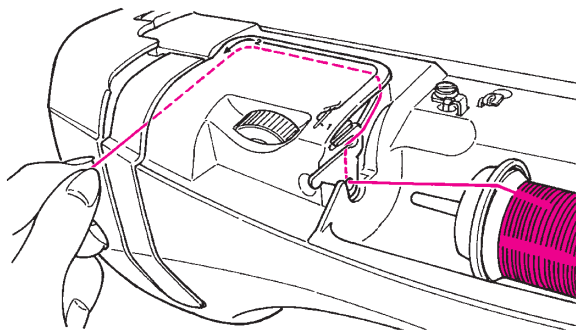

4 Hold the thread end and thread according to the arrow marking.

* Make sure that the presser foot is raised. Otherwise the machine is not correctly threaded.

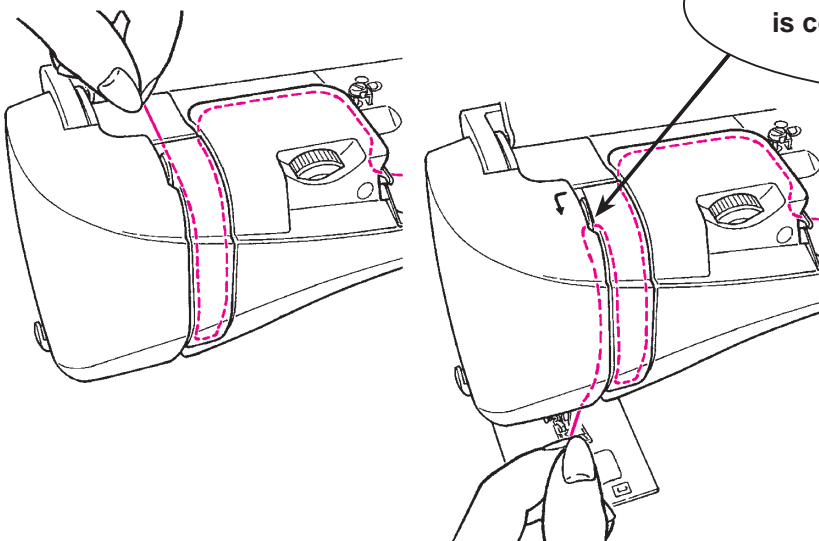

* Check that the thread take-up is correctly threaded.

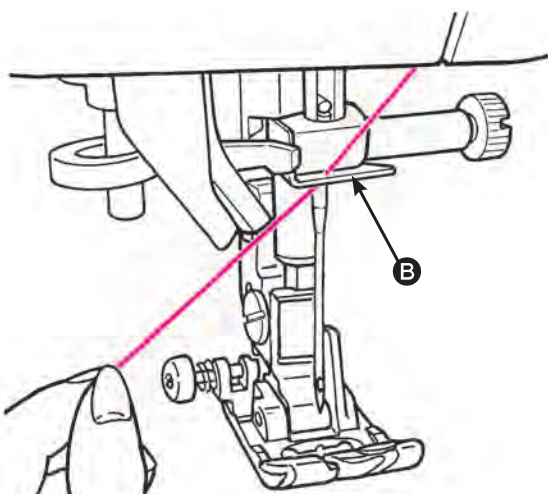

5 Thread the guide **B** from the right-hand side.

■ Automatic needle threader

Thread cutter * Be careful that the cutter is inside.

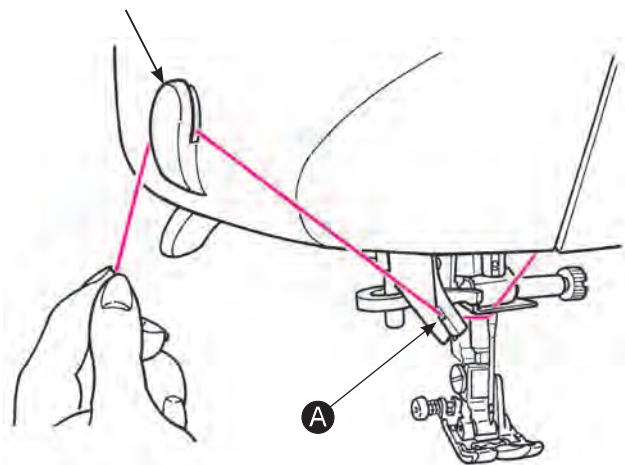

1 Lower the presser foot.

* The automatic needle threader sometimes fails to thread the needle when the presser foot is raised.

2 Thread to **A** and cut the thread with the thread cutter.

3 Lower the threading lever until it comes to a complete stop.

* Lower the threading lever slowly.

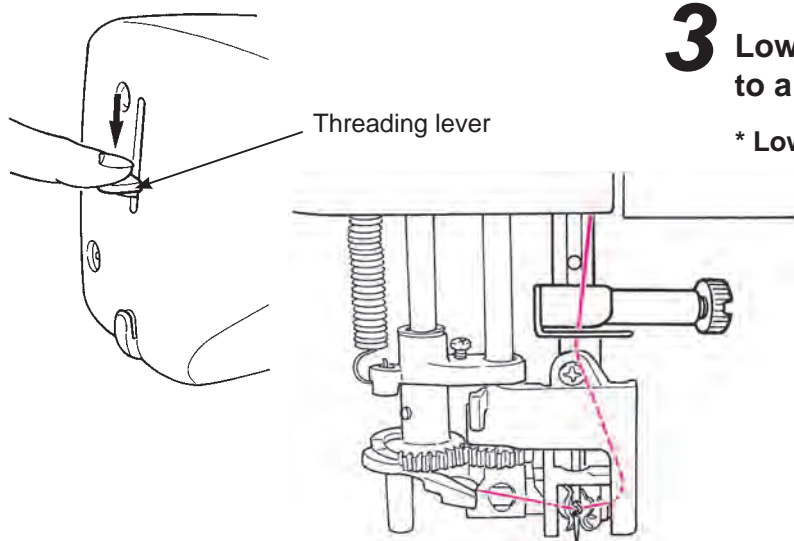

4 Release the threading lever and the needle thread is threaded to the needle eye.

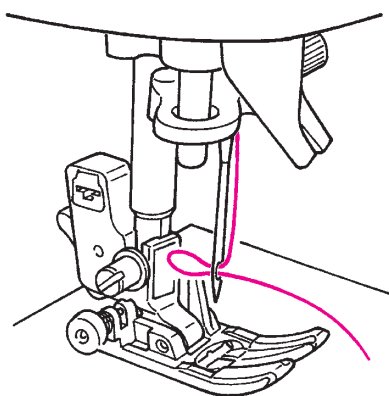

5 Pull the thread backward.

Pull out the thread from the needle eye by approx. 10 cm or 4 inches long.

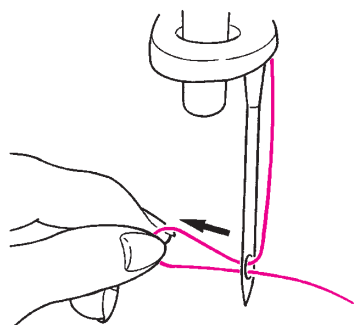

■ Pulling up the bobbin thread

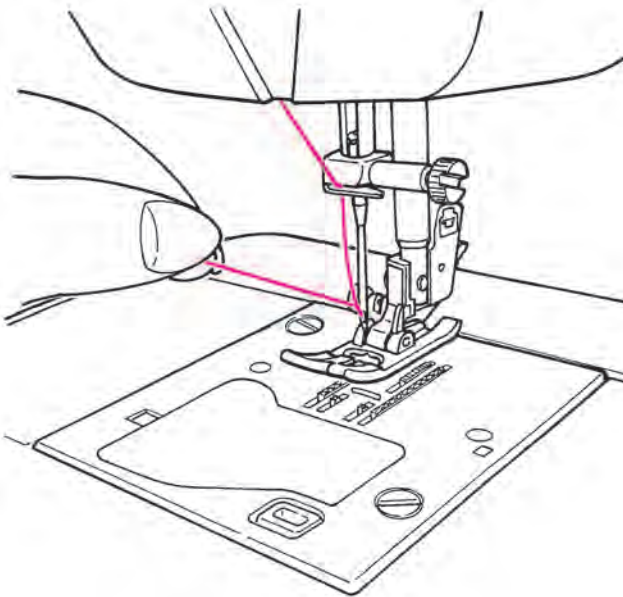

Basic operation:

You can start to sew without pulling up the bobbin thread, however, if you want to sew with the bobbin thread pulled out, follow the directions below.

1 Lift the presser foot and lightly hold the end of the needle thread.

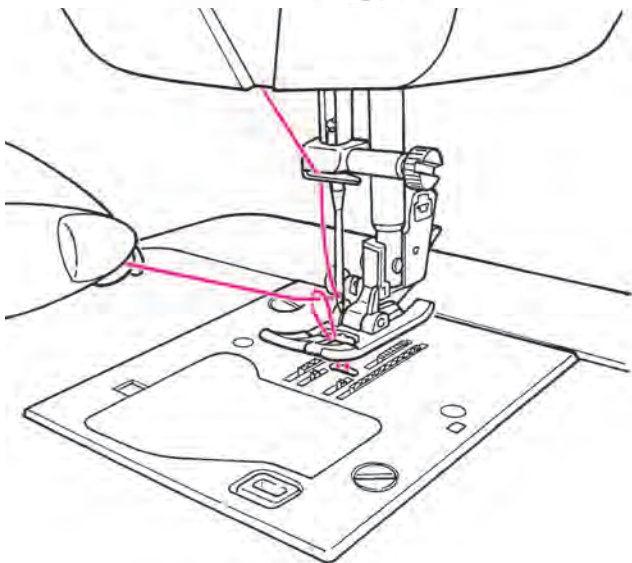

2 Turn the hand wheel towards you to move the needle up and down. Loop of bobbin thread will be pulled out when you will pull the needle thread lightly.

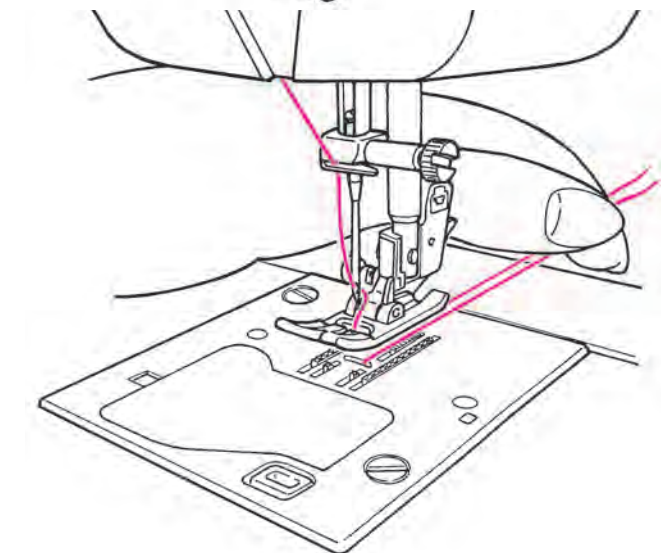

3 Pull out both needle and bobbin threads by approx. 10 cm (4 inches) long and pass them under the presser foot towards the back of the machine.

Attaching the needle



Warning

Turn OFF the power switch before changing the needle.

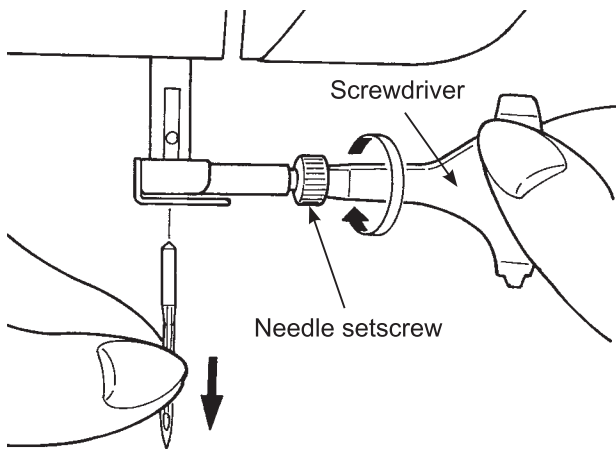

1 Removing needle

1. Turn the hand wheel towards you until the needle comes to the highest position and lower the presser foot.
2. Turn the needle setscrew towards you 1-2 times and remove the needle.

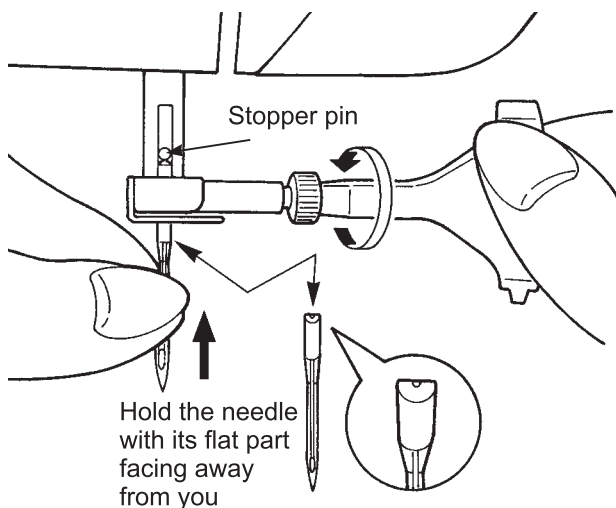

2 Attaching the needle

(The needle cannot be inserted unless it is correctly positioned.)

Hold the needle with its flat part facing away from you, and insert it fully until it touches the stopper pin. Securely tighten the needle setscrew.

■ Needles to be purchased

When purchasing spare needles, specify HA X 1 (130/705H) or HA X 1 SP (needle for knits).



Needle size:

The larger the number, the thicker the needle.

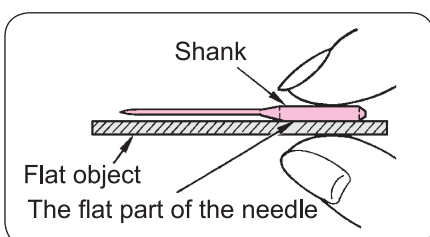

■ Checking the needle



Check the needle for its straightness occasionally. Any bent needle would cause skipped stitches, thread breakage or damage to materials.

Attention: The machine will not sew if the needle is not inserted correctly and/or a bent needle is used. It will cause damage to the machine.

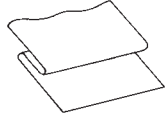
Fabric, thread and needle table

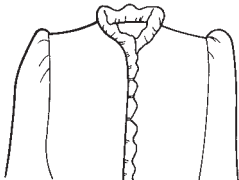
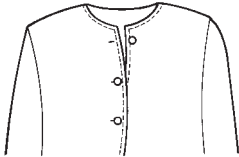
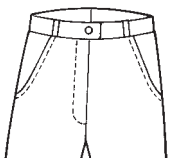
	Fabric 	Thread 	Needle  HAx1
Light-weight materials 	Lawn	Silk thread No.80,90 Spun thread No.80,90	No.11
	Georgette		
	Tricot	Spun thread No.60-90	Knit needle No.11
	Wool and synthetic fabrics	Silk thread No.80 Spun thread No.60-90	No.11-14
Medium-weight materials 	Cotton and synthetic fabrics	Spun thread No.50, 60	No.11-14
	Light jersey	Silk thread No.50 Spun thread No.50, 60	Knit needle No.11
	Ordinary wool and synthetic fabrics	Silk thread No.50 Spun thread No.50, 60	No.11-14
Heavy-weight materials 	Denim	Spun thread No.30-50	No.14-16
	Jersey	Silk thread No.50 Spun thread No.50, 60	Knit needle No.11-14
	Coat	Silk thread No.50	No.11-14

- * In general, the same thread is used for both needle and bobbin threads.
- * Thin thread and needle will be used for light-weight fabrics and thick thread and needle will be used for heavy-weight materials.
- * Check that the combination of needle and thread is OK by trial sewing on the material which will be sewn.
- * Knit needle is good for stretchy fabrics (such as knits) and synthetic fabrics.
- * Use thread No. 30 - 90.
- * When it is difficult to go over an overlapped section, guide the fabric by hand.
- * When sewing decorative stitches or letters (Page 28, 30 and 32), use knit needle for better finish.

How to adjust thread tension

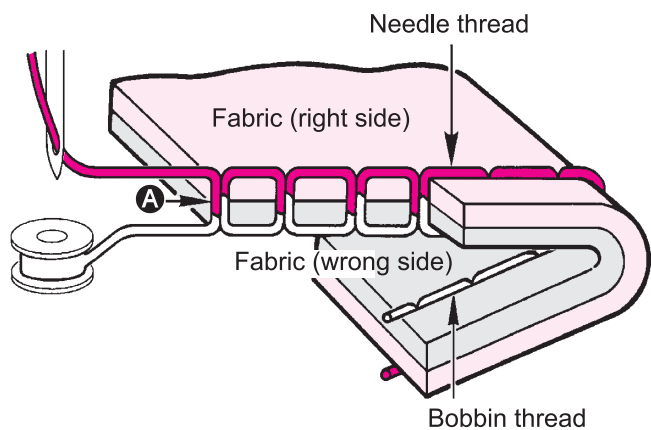

Well-balanced thread tension

Straight stitch: Needle and bobbin threads interlace with each other at the middle of the fabric thickness. (A)

Zigzag stitch: Needle thread is pulled a little bit to the wrong side of the fabric.

If the machine is set to "Auto", it is suitable for most fabrics. However, adjustment may be necessary according to fabrics and sewing applications. If the tension is not correctly set, it will cause imbalanced stitch formation, puckering, and/or thread breakage.

Thread tension adjustment dial

Weaker tension Stronger tension

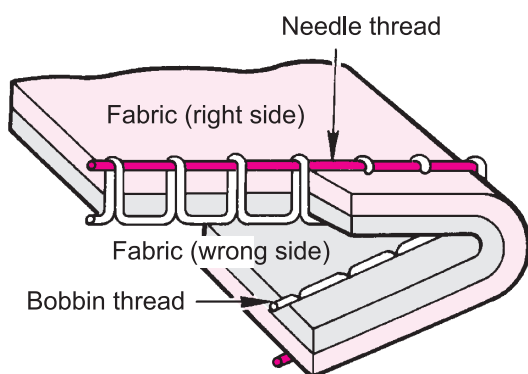
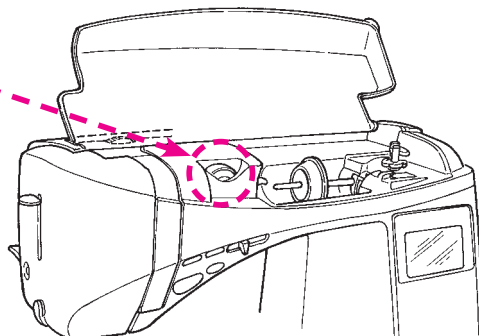

When the needle thread is too strong:

The bobbin thread will be pulled to the front side of the fabric. Turn the thread tension adjustment dial towards "-1" to "-3".

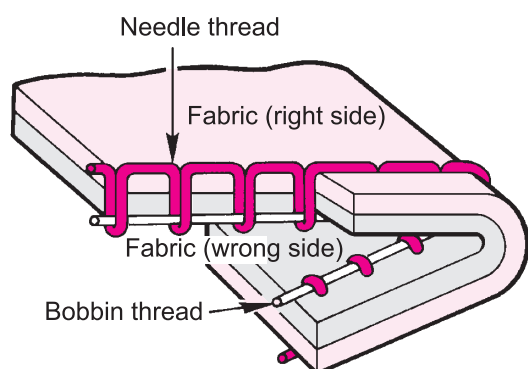

When the needle thread is too low:

The needle thread will be pulled to the wrong side of fabric. Turn the thread tension adjustment dial towards "+1" to "+3".

In case a correct tension setting is not obtained, check thread paths for both needle and bobbin threads.

How to adjust the presser foot pressure / How to lower the feed dog

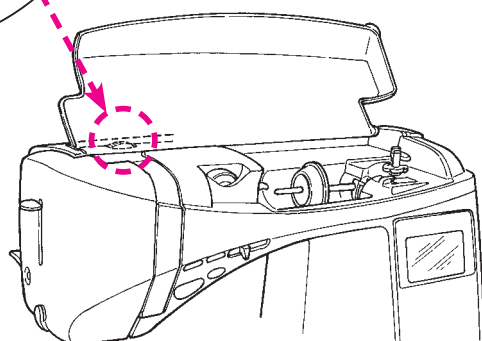
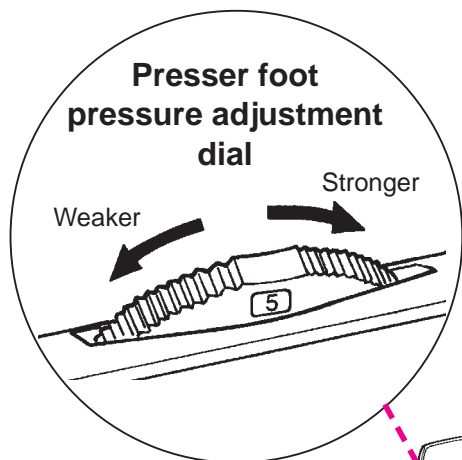

■ How to adjust presser foot pressure

Turn the presser foot pressure adjustment dial to set the proper pressure.

When sewing in general, set the presser foot pressure adjustment dial to "5".

When sewing on light synthetic fabrics, stretchy fabrics, appliqué which seam allowance is overlapped, etc., lower the number on the presser foot pressure adjustment dial. (reducing the presser foot pressure)

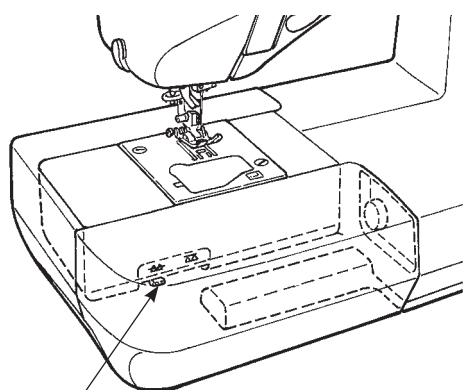

Drop feed knob

■ How to lower the feed dog

Move the drop feed knob to the right-hand side, in case the feed dog is in the down position for free motion quilting, button sewing, etc.

* Move the drop feed knob to the left-hand side after sewing. The feed dog will be engaged automatically when the machine starts to sew.

★ When lowering the feed dog

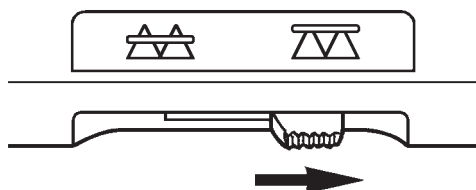



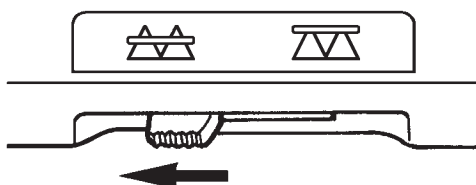

★ When lifting the feed dog













How to select a stitch pattern

- ☆ There are 225 types of stitch patterns.
- ☆ When turning on the machine, the straight stitch of the center needle position is chosen automatically.
- ☆ There are 4 methods to select stitch pattern.

1 Direct patterns

Push    and check the stitch pattern in this portion and select. 



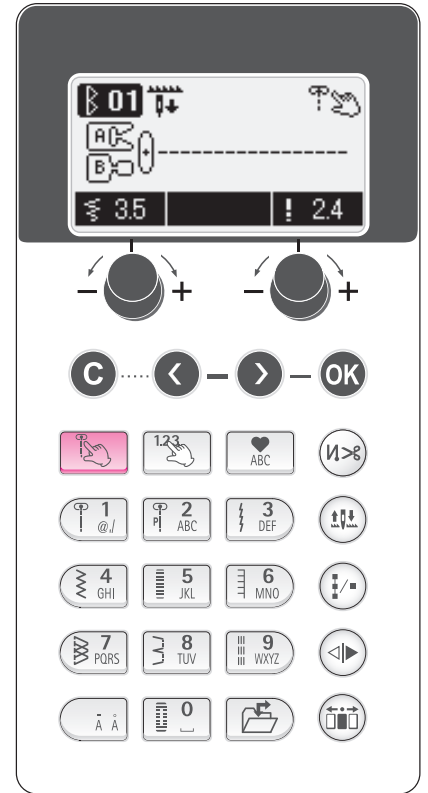

 will be indicated on top right side of the screen.

Pattern No.	1	2	3	4	5	6	7	8	9	0
Pattern										
Application	Center needle position Straight stitch	Piecing	Straight stitch for elastic	Zigzag stitch	Applique		Over casting stitch	Blind stitch	Straight reinforced stitch	Buttonhole
Refer to page	33	63	37	38	64	65	39	41	37	44

On the LCD screen you will see the selected stitch pattern and the marking of the presser foot to be used.



2 Other patterns

Push    and choose stitch pattern type. 



















Select stitch pattern by number.

 will be indicated on top right side of the screen.



• Practical patterns



Pattern No.	01	02	03	04	05	06	07	08	09	10	11	12	13	14	15	16	17	18	19	20	21	22	23
Pattern																							
Application	Left needle position Straight stitch	Center needle position Lock stitch (stay stitches)	Left needle position Zigzag stitch	Right needle position Zigzag stitch	Three point zig zag	Two point zig zag	Overcasting stitch	Overcasting stitch Used for lightweight material	Overcasting stitch Used for flexible material	Overcasting stitch Used for lightweight material	Ornamental pattern	Blind stitch Used for flexible material	Blind stitch Used for lightweight material	Shell tuck	Back straightline stitch	Back zigzag stitch	Fly stitch	Bar tack	Eyelet	Eyelet	Darning	Button sewing	
Refer to page	33	37	38	40	-	39	40	-	-	-	-	-	41	-	37	-	-	52	-	-	71	-	

• Buttonhole patterns

Pattern No.	01	02	03	04	05	06	07	08	09	10	11	12	13	14	15
Pattern															
Application	Standard buttonholes		2-step buttonhole	Rounded end	Keyhole buttonholes			For knit			Decorative				
Refer to page	44														

• Quilt patterns

Pattern	01	02	03	04	05	06	07	08	09	10	11	12	13	14	15	16	17
Pattern																	
Patterns for crazy quilt																	
Pattern																	
Pattern																	
Pattern																	
Refer to page	65																

• Decorative patterns

Pattern	01	02	03	04	05	06	07	08	09	10	11	12	13	14	15	16	17	18
Pattern																		
Pattern																		
Pattern																		
Pattern																		
Refer to page	62																	

③ One point pattern

Push and choose

Check the number in this portion and select.

will be indicated on top right side of the screen.

Pattern	01	02	03	04	05	06	07	08	09	10	11	12	13	14	15
Pattern															
Pattern															
Patterns for elongation															
Pattern															
Refer to page	71~78, 89														

④ Letters

Push and choose

Check this portion.

Input letters by cell phone input. (Refer to page 73)





will be indicated on top right side of the screen.

Pattern	A	B	C	D	E	F	a	b	c	d	e	f	1	2	3	4	5	6	@	!	&	'	Ä	Å
Pattern																								
Pattern																								
Refer to page	71-78																							











How to select a stitch pattern

- ☆ There are 157 types of stitch patterns.
- ☆ When turning on the machine, the straight stitch of the center needle position is chosen automatically.
- ☆ There are 4 methods to select stitch pattern.

1 Direct patterns

Push    and check the stitch pattern in this portion and select. 

 will be indicated on top right side of the screen.

Pattern No.	1	2	3	4	5	6	7	8	9	0
Pattern										
Application	Center needle position Straight stitch	Piecing Straight stitch for elastic	Straight stitch for elastic	Zigzag stitch	Applique		Overcasting stitch	Blind stitch	Straight reinforced stitch	Buttonhole
Refer to page	33	63	37	38	64	65	39	41	37	44

On the LCD screen you will see the selected stitch pattern and the marking of the presser foot to be used.

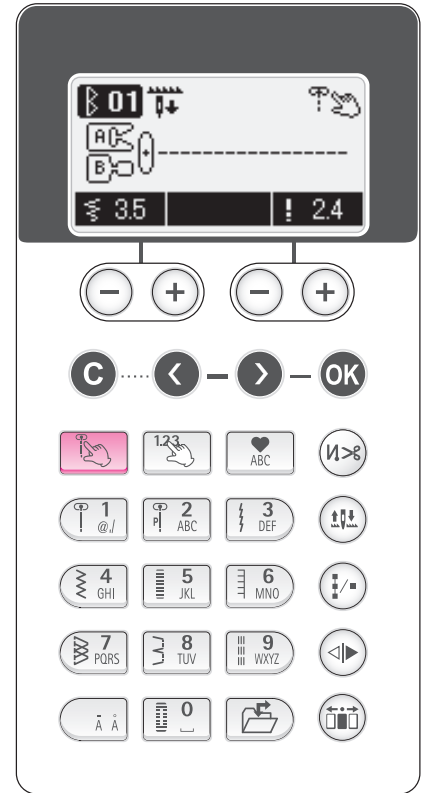

2 Other patterns

Push    and choose stitch pattern type. 

















Select stitch pattern by number. 

 will be indicated on top right side of the screen.



• Practical patterns



Pattern No.	01	02	03	04	05	06	07	08	09	10	11	12	13	14	15	16	17	18	19	20	21
Pattern																					
Application	Left needle position Straight stitch	Center needle position Lock stitch (stay stitches)	Left needle position Zigzag stitch	Right needle position Zigzag stitch	Three point zig zag	Two point zig zag	Overcasting stitch	Overcasting stitch Used for lightweight material	Overcasting stitch Used for flexible material	Overcasting stitch Used for flexible material	Ornamental pattern	Blind stitch Used for flexible material	Blind stitch Used for lightweight material	Shell tuck	Fly stitch	Bar tack	Eyelet	Eyelet	Darning	Button sewing	Button sewing
Refer to page	33	37	38	38	40	-	39	40	-	-	-	-	41	-	-	52	-	-	71	-	-

• Buttonhole patterns



Pattern No.	01	02	03	04	05	06	07	08	09	10	11	12	13	14	15
Pattern															
Application	Standard buttonholes			2-step buttonhole		Rounded end		Keyhole buttonholes			For knit			Decorative	
Refer to page	44														

• Quilt patterns



Pattern	01	02	03	04	05	06	07	08	09	10	11	12	13	14	15	16	17	18	19	20	21	22	23	24	25	26	27	28	29
Refer to page	65																												

• Decorative patterns



Pattern	01	02	03	04	05	06	07	08	09	10	11	12	13	14	15	16	17	18	19	20	21	22	23	24	25	26	27	28	29	30	31	32	33	34	35	36	37	38	39	40	41	42	43	44	45	46	47	48	49
Refer to page	62																																																

③ One point pattern

Push and choose . Check the number in this portion and select. will be indicated on top right side of the screen.

Pattern	01	02	03	04	05	06	07	08	09	10	11	12	13	14	15	16	17	18	19	20	21	22	23	24	25	26	27	28	29	30	31	32	33
Refer to page	71~78, 89																																

④ Letters



Push and choose . Check this portion. Input letters by cell phone input. (Refer to page 73) will be indicated on top right side of the screen.

Pattern	A B C D E F	a b c d e f	1 2 3 4 5 6	@ ! & ' Ä Å	A B C D E F	a b c d e f	1 2 3 4 5 6	@ ! & ' Ä Å	A B C D E F	a b c d e f	1 2 3 4 5 6	@ ! & ' Ä Å
Refer to page	71~78											











How to select a stitch pattern

- ☆ There are 105 types of stitch patterns.
- ☆ When turning on the machine, the straight stitch of the center needle position is chosen automatically.
- ☆ There are 4 methods to select stitch pattern.

1 Direct patterns

Push    and check the stitch pattern in this portion and select.

 will be indicated on top right side of the screen.

Pattern No.	1	2	3	4	5	6	7	8	9	0
Pattern										
Application	Center needle position Straight stitch	Piecing for elastic	Straight stitch for elastic	Zigzag stitch	Applique	Over casting stitch	Blind stitch	Straight reinforced stitch	Buttonhole	Buttonhole
Refer to page	33	63	37	38	64	65	39	41	37	44

On the LCD screen you will see the selected stitch pattern and the marking of the presser foot to be used.



2 Other patterns

Push    and choose stitch pattern type.



















Select stitch pattern by number. 

 will be indicated on top right side of the screen.



• Practical patterns



Pattern No.	01	02	03	04	05	06	07	08	09	10	11	12	13	14	15	16	17	18	19	20	21
Pattern																					
Application	Left needle position Straight stitch	Center needle position Lock stitch (stay stitches)	Left needle position Zigzag stitch	Right needle position Zigzag stitch	Three point zig zag	Two point zig zag	Overcasting stitch	Overcasting stitch Used for lightweight material	Overcasting stitch Used for flexible material	Overcasting stitch Used for flexible material	Ornamental pattern	Blind stitch Used for flexible material	Blind stitch Used for lightweight material	Shell tuck	Fly stitch	Bar tack	Eyelet	Eyelet	Darning	Button sewing	Button sewing
Refer to page	33	37	38	38	40	-	39	40	-	-	-	-	41	-	-	52	-	-	71	-	-

• Buttonhole patterns



Pattern No.	01	02	03	04	05	06	07	08	09	10	11	12	13	14	15
Pattern															
Application	Standard buttonholes		2-step buttonhole	Rounded end	Keyhole buttonholes			For knit			Decorative				
Refer to page	44														

• Quilt patterns



Pattern	01	02	03	04	05	06	07	08	09	10	11	
Pattern	12	13	14	15	16	17	18	19	20	21	22	
Refer to page	65											

• Decorative patterns



Pattern	01	02	03	04	05	06	07	08	09	10
Pattern	11	12	13	14	15	16	17	18	19	20
Refer to page	62									

③ One point pattern

Push and choose . Check the number in this portion and select. will be indicated on top right side of the screen.





Pattern	01	02	03	04	05	06	07	08	09	10		
Pattern	11	12	Patterns for elongation				13	14	15	16	17	18
Refer to page	71~78, 89											

④ Letters

Push and choose . Check this portion . will be indicated on top right side of the screen. Input letters by cell phone input. (Refer to page 73) will be indicated on top right side of the screen.

Pattern	A B C D E F	A B C D E F
	a b c d e f	a b c d e f
	1 2 3 4 5 6	1 2 3 4 5 6
	@ ! & ' Ä Å	@ ! & ' Ä Å
Pattern	A B C D E F	A B C D E F
	a b c d e f	a b c d e f
	1 2 3 4 5 6	1 2 3 4 5 6
	@ ! & ' Ä Å	@ ! & ' Ä Å
Refer to page	71~78	

Straight stitch

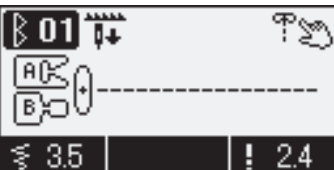
					
		Pattern No. Direct 1	Presser foot Standard presser foot (A)		
		Thread tension Auto			

Attention

Turn OFF the power switch before replacing the presser foot.

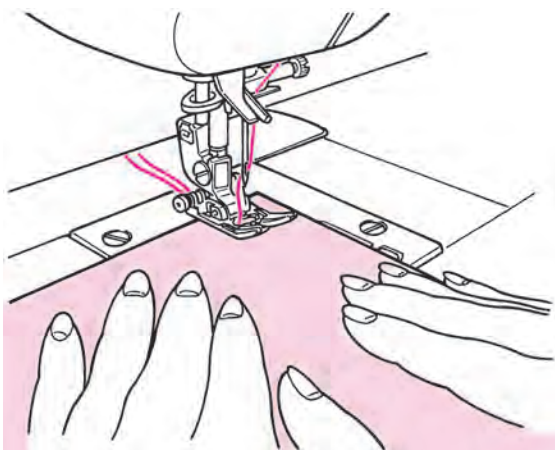

■ Sewing start

Pull the needle and bobbin threads under the presser foot to the rear of the machine and lower the presser foot to start sewing.

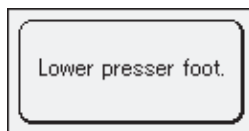

This means presser foot is up. Lower the presser foot to start sewing.

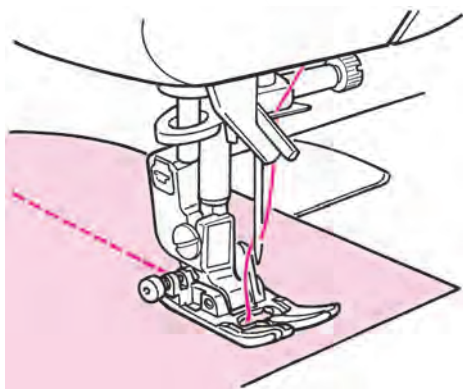

■ Sewing end

Stop sewing and push the thread trimming button to trim the threads.

<by thread trimming button>

Push the thread trimming button to trim the threads.

<by foot controller>

Push heel side of the foot controller to trim the threads.

* This function can be cancelled.
(Refer to page 82.)

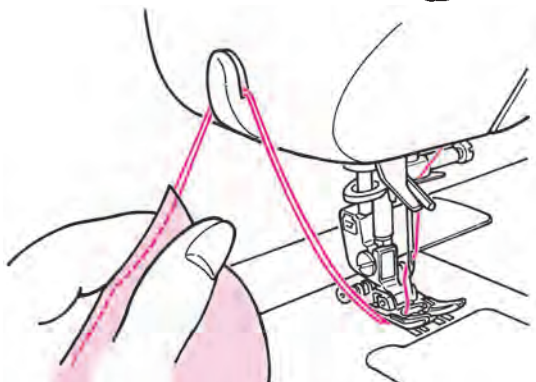
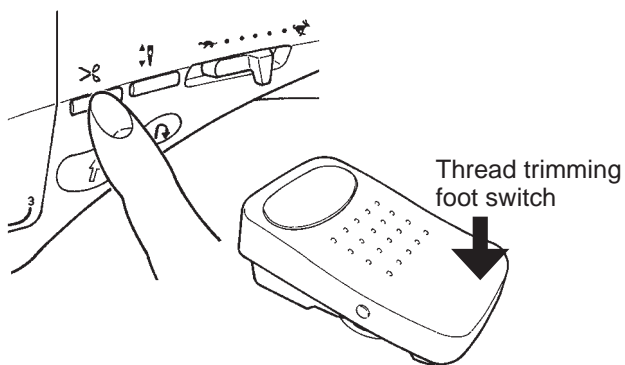

* You can also cut the threads by the thread cutter at the face plate cover.

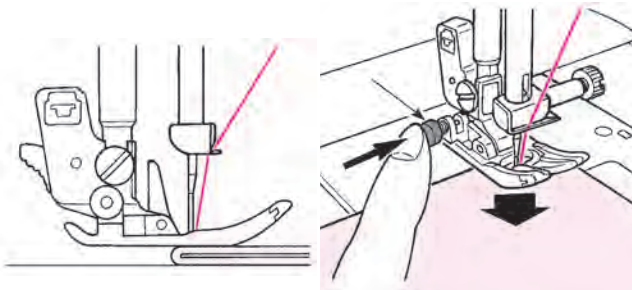

■ When sewing the edge of thick fabrics

Turn the hand wheel and let the needle enter at the position of sewing start. Push the black button by finger and lower the presser foot. Release the finger from the black button and start sewing. When the presser foot will be on the fabric completely, the black button will be disengaged automatically.

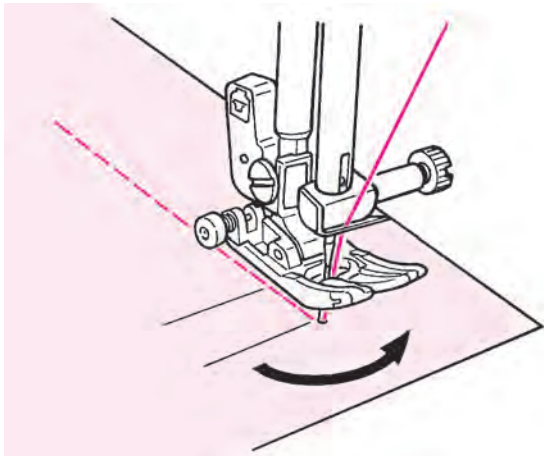

■ When changing the sewing direction

Stop sewing in front of the predetermined position and then continue to sew, stitch by stitch, by using needle up/down button until the target point. Leave the needle inside the fabrics and raise the presser foot. With the needle inside the fabrics change the sewing direction, lower the presser foot and then start sewing.

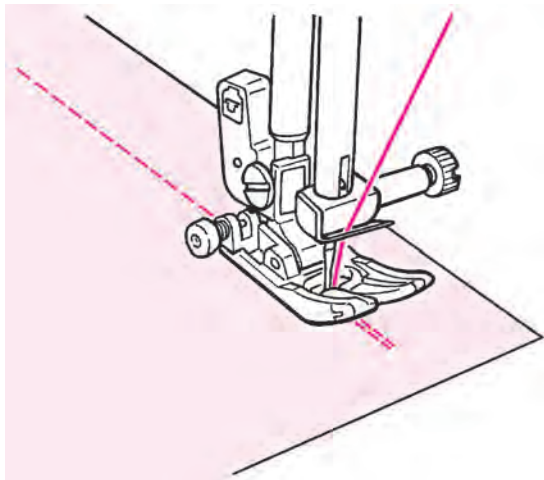

■ Lock stitch after sewing-end

<When start/stop button is used>

After the sewing is finished, push the reverse stitch button. While it is pressed, the machine will sew reverse and when it is released, the machine will stop sewing reverse.

*When reverse stitching, the sewing speed is slow.

<When foot controller is used>

The machine will sew reverse at almost the same speed as the normal sewing. When the reverse stitch button is released, the machine sews straight.

On center needle position basis

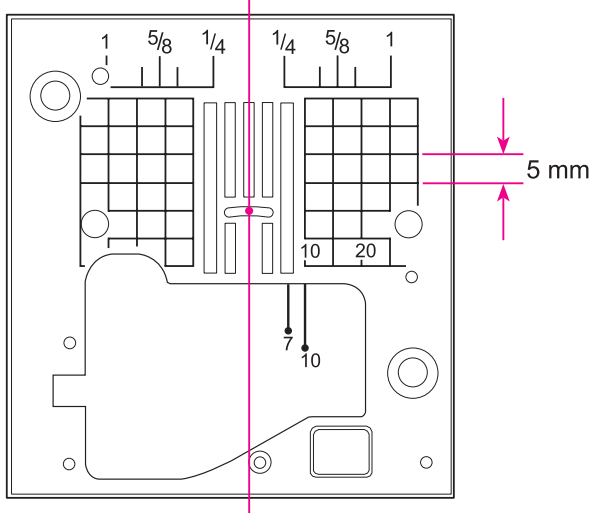

★ Seam guide line on the throat plate

Align the fabric edge with a seam guide line and sew.

* Numbers on the guide line show the distance in mm and inches between the center needle position and the guide line.

Numbers, 7, 10 and 20 are millimeter.

Numbers, 1/4, 5/8 and 1 are inches.

★ Automatic lock stitch and thread trimming

After selecting a stitch pattern, push  one time.



The machine will sew a few reverse stitches (lock stitches), trim both needle and bobbin threads and stop.

Symbol on screen: 

When  is pushed once again, this function will be cancelled.

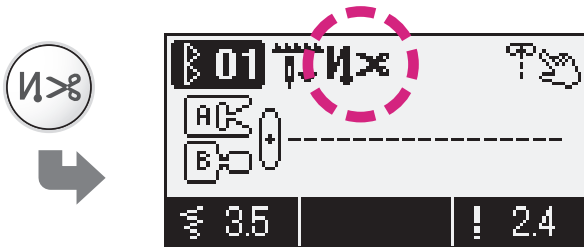
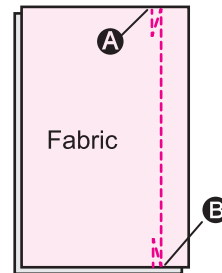
Example: straight stitch



1 After selecting a pattern, you can press  to display  on the screen.

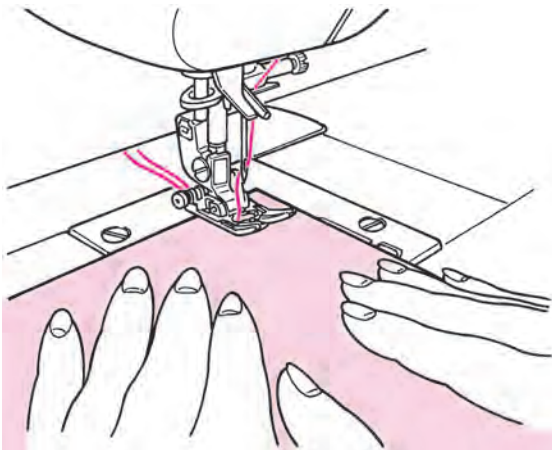

2 Place the fabric in the sewing start position and begin sewing. **A**

The machine sews a few back stitches and continue.

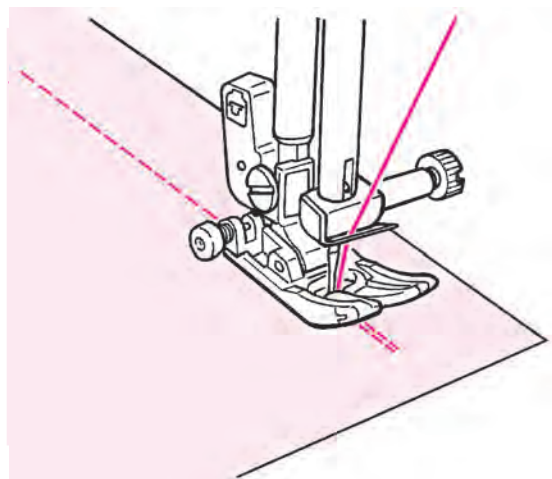

3 Press the reverse stitch button. **B**

The machine sews reverse stitches, stop sewing and trim both needle and bobbin threads automatically.

★ How to change needle positions / How to change the stitch length

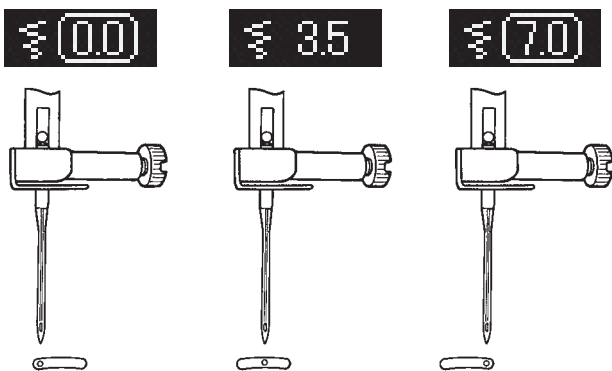
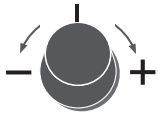
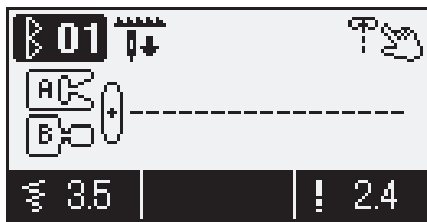

■ When changing the needle position of straight stitch

It is possible to change the needle position with the zigzag width adjusting dial/button.

F600 Only

Turning to the left (- side), the needle moves to the left. Turning to the right (+ side), the needle moves to the right.

F400 / F300

Pushing "-", the needle moves to the left. Pushing "+", the needle moves to the right.

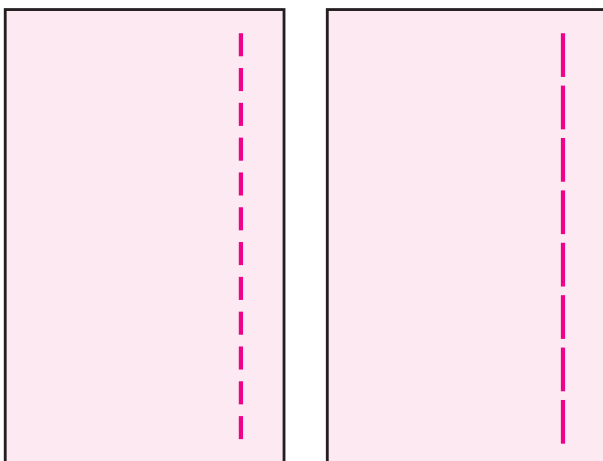
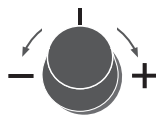
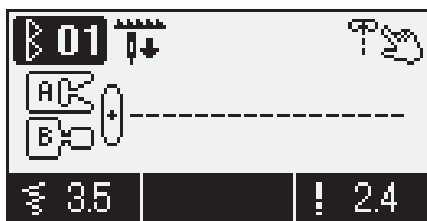

■ When changing the stitch length

It is possible to change the stitch length with the stitch length adjusting dial/button.

F600 Only

Turning to the left (- side), the displayed value becomes smaller and the stitch length becomes smaller accordingly. Turning to the right (+ side), the displayed value becomes larger and the stitch length becomes larger.

F400 / F300

Pushing "-", the displayed value becomes smaller and the stitch length becomes smaller accordingly. Pushing "+", the displayed value becomes larger and the stitch length becomes larger.

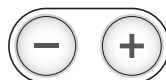

★ Other straight stitch patterns

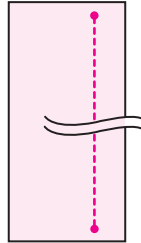
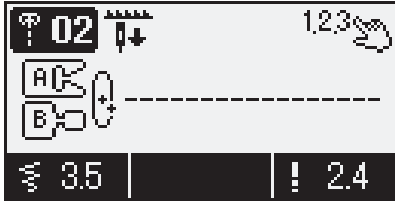

■ Lock stitch (stay stitches)

At the sewing-end, push the reverse stitch button. The machine will sew several stay stitches and stop.

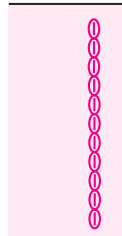
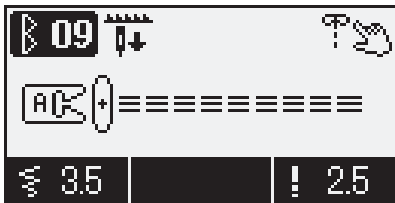

■ Reinforced stretch stitch

The reinforcing stretch stitch helps reinforce seams when used for sewing of elastic fabric or the force-exerted part of fabric that is likely to fray.

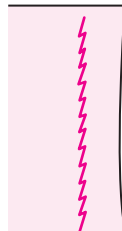
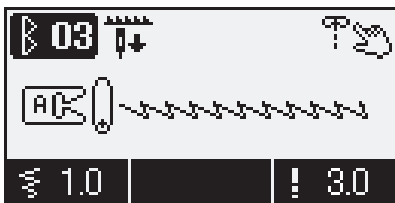

■ Straight stitch for elastic fabric

Finished seams are elastic. This stitch system can be used for producing straight stitches on elastic fabrics such as knits and jersey.

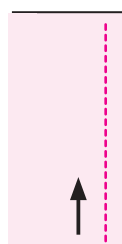
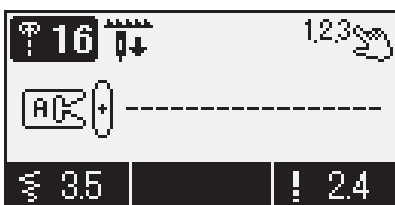

F600 Only

■ Reverse straight stitch

Machine starts to sew reverse and when reverse stitch button is pushed, it sews forward.

Zigzag stitch

	Pattern No. Direct 4
	Presser foot Standard presser foot (A)

⚠ Attention

Turn OFF the power switch before replacing the presser foot.

■ When changing the zigzag width

The zigzag width can be adjusted while sewing.

F600 Only

Turning to the left (- side), displayed value becomes smaller and the zigzag width becomes smaller accordingly. Turning to the right (+ side), displayed value becomes larger and the zigzag width becomes larger accordingly.

F400 / F300

Pushing "-", displayed value becomes smaller and the zigzag width becomes smaller accordingly. Pushing "+", displayed value becomes larger and the zigzag width becomes larger accordingly.

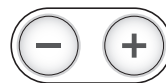

■ When changing the stitch length

The stitch length can be adjusted while sewing.

F600 Only

Turning to the left (- side), the displayed value becomes smaller and the stitch length becomes smaller accordingly. Turning to the right (+ side), the displayed value becomes larger and the stitch length becomes larger accordingly.

F400 / F300

Pushing "-", the displayed value becomes smaller and the stitch length becomes smaller accordingly. Pushing "+", the displayed value becomes larger and the stitch length becomes larger accordingly.

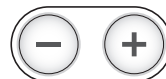

Overcasting stitch

- This stitch is used to prevent the edge of fabric from fraying.

Overcasting stitch 1

	Pattern No. Direct 7
	Presser foot Overcasting presser foot (C)

Attention
Turn OFF the power switch before replacing the presser foot.

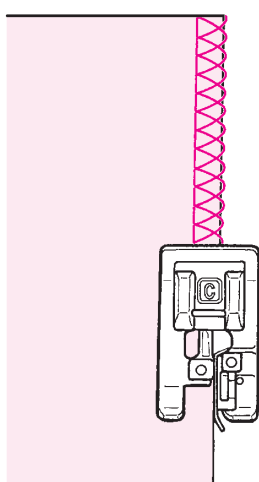

Push the fabric towards the guide and sew. If the fabric and guide are apart, it will not make a nice stitch formation. Make sure to guide the fabric along the guide and sew slowly.

* Before sewing, make sure to check that the needle will not hit the presser foot.

Overcasting stitch 2

	Pattern No. Practical 07
	Presser foot Overcasting presser foot (C)



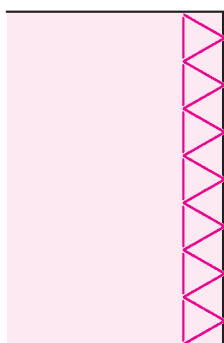



Attention
Turn OFF the power switch before replacing the presser foot.



This stitch is used for overcasting medium- to heavy-weight materials. Guide the fabric along the guide and sew.

* Before sewing, make sure to check that the needle will not hit the presser foot.

■ Overcasting stitch 3

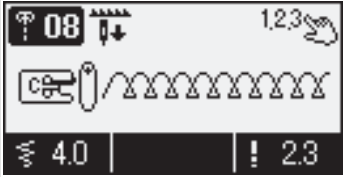
			+		+		
		Pattern No.	Practical 08 (Light-weight material)				
		Presser foot	Overcasting presser foot (C)				

Attention

Turn OFF the power switch before replacing the presser foot.

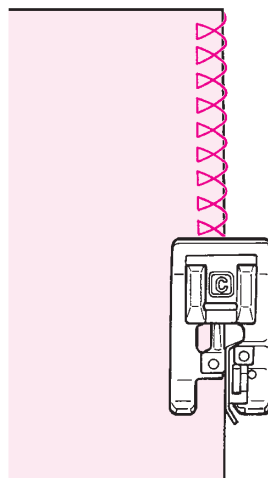







This overcasting stitch is used for overcasting light-weight materials.

Guide the fabric along the guide and sew.

* Before sewing, make sure to check that the needle will not hit the presser foot.

■ Overcasting by 3-point zigzag

			+		+		
		Pattern No.	Practical 05				
		Presser foot	Standard presser foot (A)				

Attention

Turn OFF the power switch before replacing the presser foot.

* Do not use overcasting presser foot (C).

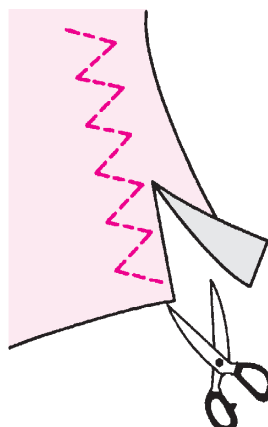

This stitch is used to prevent the cut edge of fabric from fraying.

Keep some seam allowance and cut the sewn fabric carefully so that stitches are not cut by the scissors.

Blind stitch

	Pattern No. Direct 8 Practical 13 (Light-weight material) Practical 14 (Stretchy fabrics)
	Presser foot Blind stitch presser foot (D)

Attention

Turn OFF the power switch before replacing the presser foot.

Folding fabrics

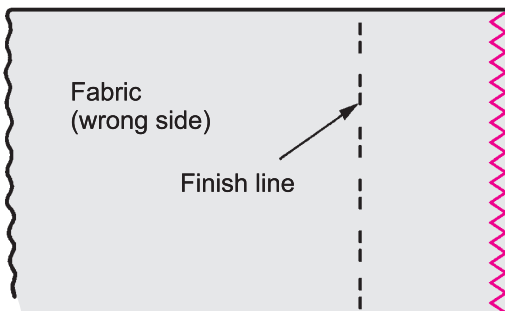

1 Sewing overcasting stitches on the edge of fabric.

- Refer to pages 39 and 40 for overcasting stitches.

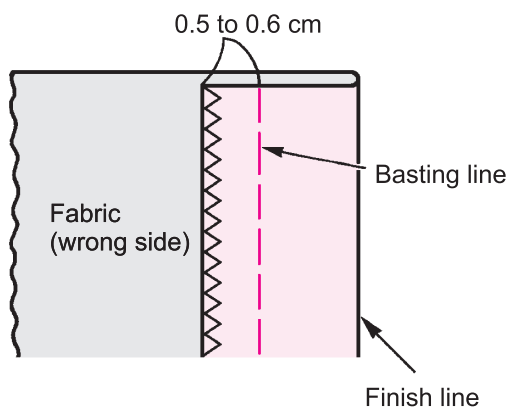

2 Basting.

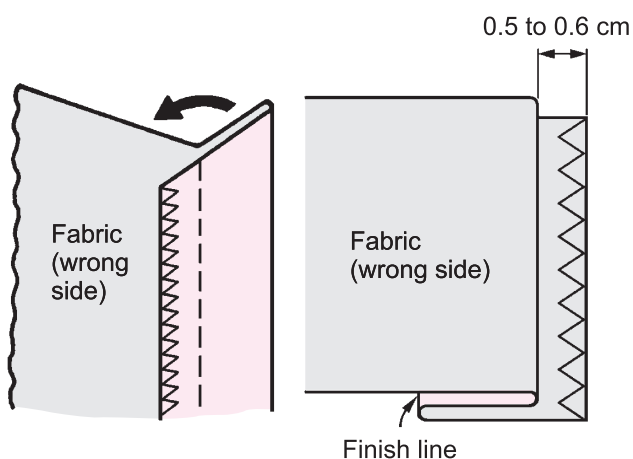

3 Fold from basting line.

Leave 0.5 to 0.6 cm.

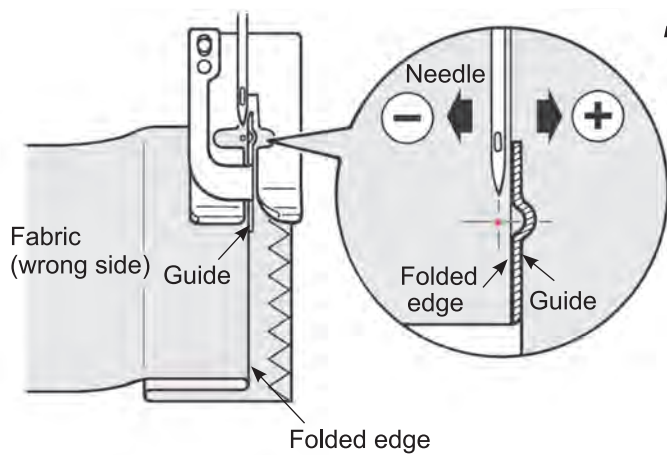

4 Align the guide of the presser foot with the folded edge.
Turn the hand wheel and adjust with the zigzag width adjusting dial so that stitches reach the folded edge.

* Pay attention so that needle will not hit the presser foot.

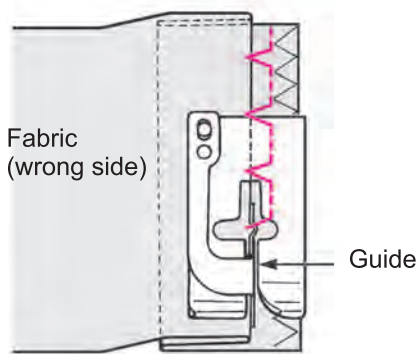

5 Position the folded edge against the guide and sew.

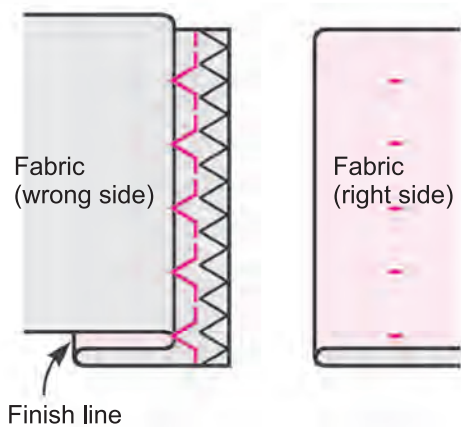

6 Turn over the fabric after sewing.

■ When changing the needle entry point

1. If the stitches reach too far beyond the folded edge

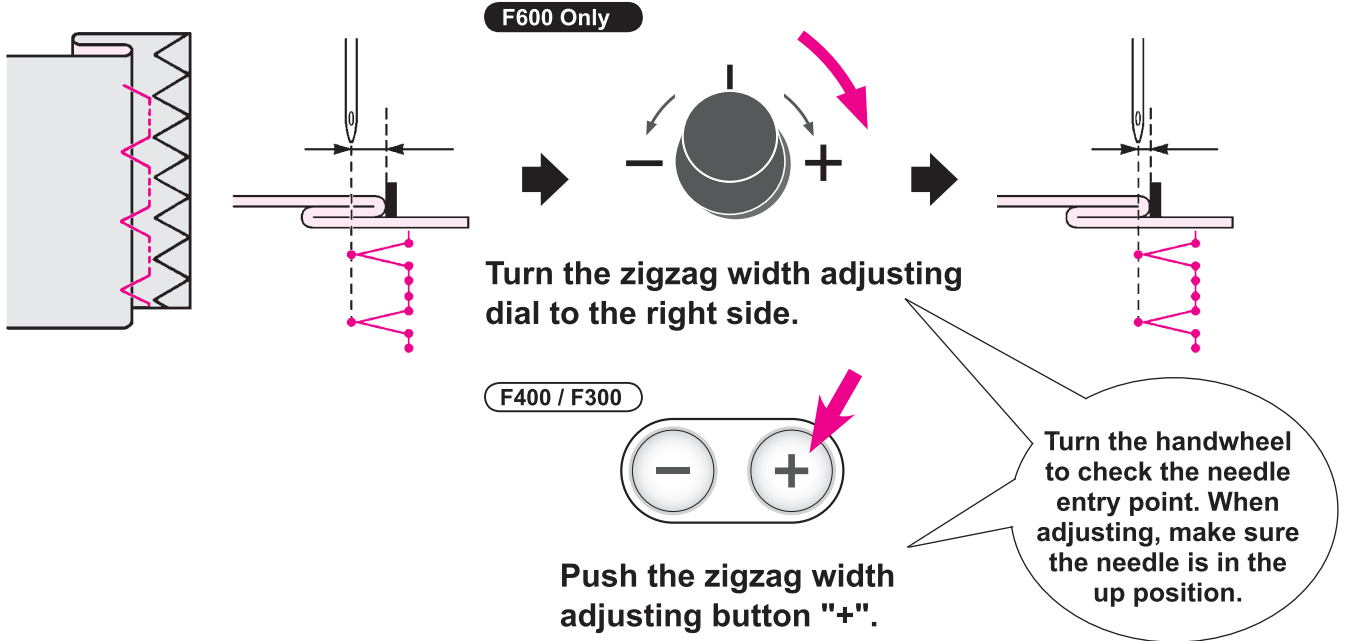

2. If the stitches fail to reach the folded edge

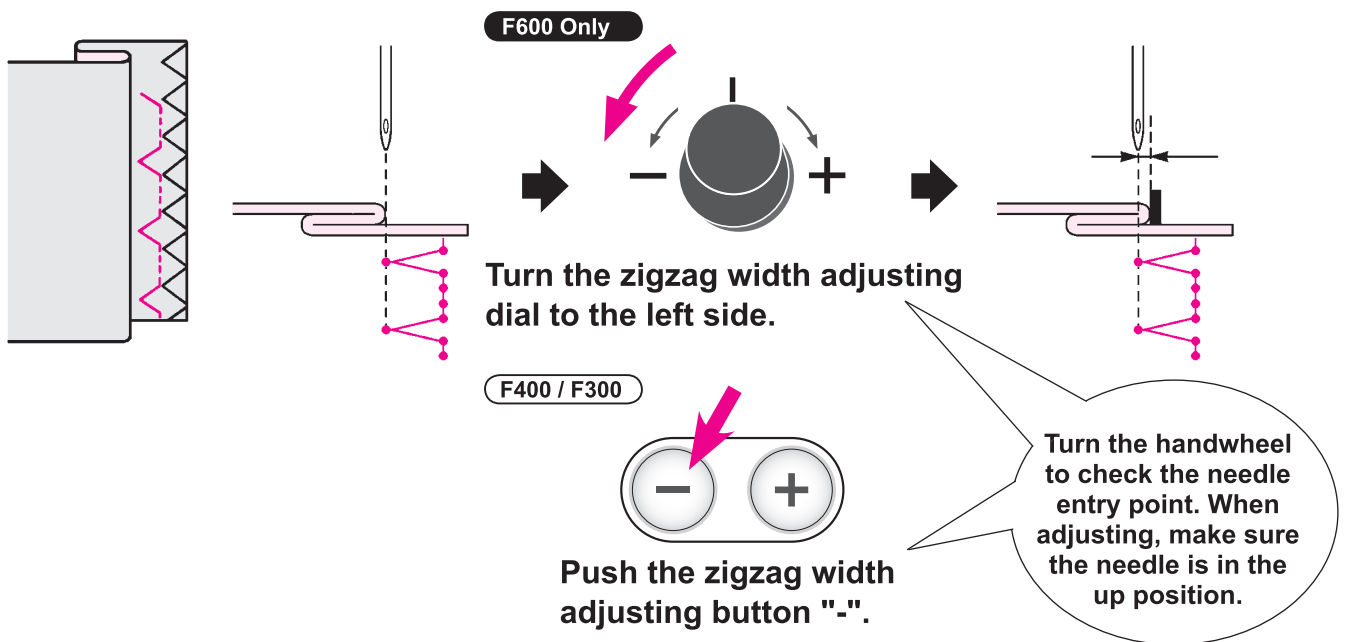

Buttonhole stitches

Attention

Turn OFF the power switch before replacing the presser foot.

- * The buttonhole length is automatically determined only by placing a button on the buttonhole presser foot.
- * The machine can sew buttonholes for buttons with diameters of 0.7 - 3.2 cm.
- * In case of stretchy fabrics, use non-elastic interlining on the wrong side of the fabric.
- * Make sure to perform test sewing to see that the machine sews buttonholes correctly.
- * Buttonhole Nos. 09 - 12 are for knit fabrics and should be used with a knit needle.

Buttonhole type

0		Standard buttonhole	Buttonhole for medium to heavy weight materials Standard buttonhole	09		For knit	Buttonhole for light weight knit (also used as decorative buttonhole)
01			Stitch length is larger. Buttonhole for heavy weight materials	10			Buttonhole for medium weight knit (also used as decorative buttonhole)
02			Sews buttonhole double	11			Buttonhole for light weight knit Sews buttonhole double
03			Manual 2-step buttonhole Use this buttonhole, when there is an overlapped section in the fabric or when you want to sew larger buttonhole than 3.2cm diameter. (Refer to page 50)	12			Buttonhole for medium weight knit Sews double buttonhole
04		Rounded end	Buttonholes for women's blouses and children's clothes. Also for light weight materials	13		Decorative	Decorative buttonholes Decorative buttonhole which look like hand-sewn
05			Keyhole buttonhole for heavy weight materials such as suits, jackets, coats, etc.	14			
06		Keyhole	Round keyhole	15			
07			Large and thick keyholes for heavy weight materials				
08							

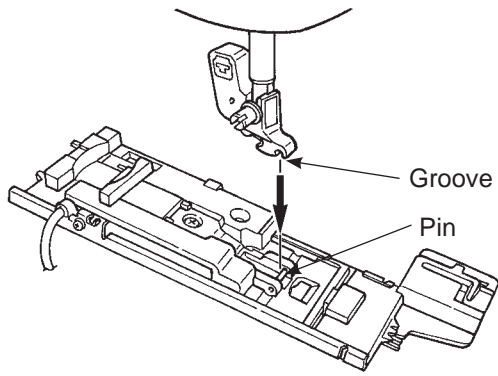

1 Set the presser foot.

Push the needle up/down button to raise the needle and lift the presser foot.

Align the groove of the presser foot holder with the pin of the presser foot and lower the presser foot holder to set.

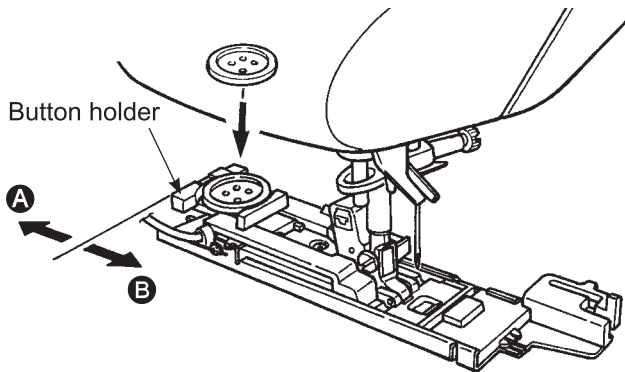

2 Set the button.

Pull the button holder toward **A**, place the button on the button holder, and then push the holder toward **B** to set the buttonhole length.

* It is impossible to set a button thicker than 4mm.

* Check the following points after setting the presser foot and then start to sew buttonholes.

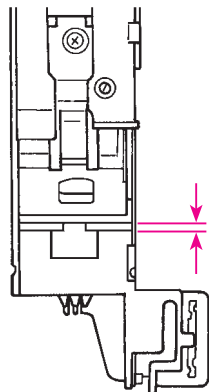

Check that there is a clearance.

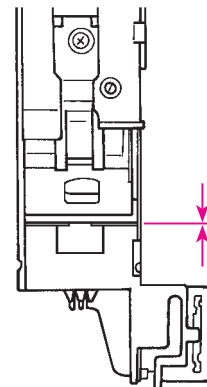

If there is not a clearance, the machine will not sew neat stitches.

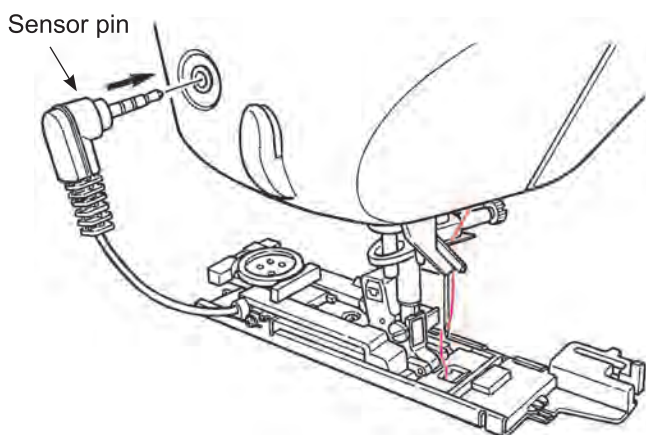

3 Set the buttonhole sensor pin.

Insert the sensor pin into the sensor pin hole at the face plate cover.

* Insert the pin into the hole completely.

* If the machine starts to sew without inserting the pin into the hole, the following message will be shown on the display.

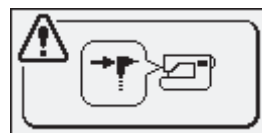

Set the sensor pin and restart.

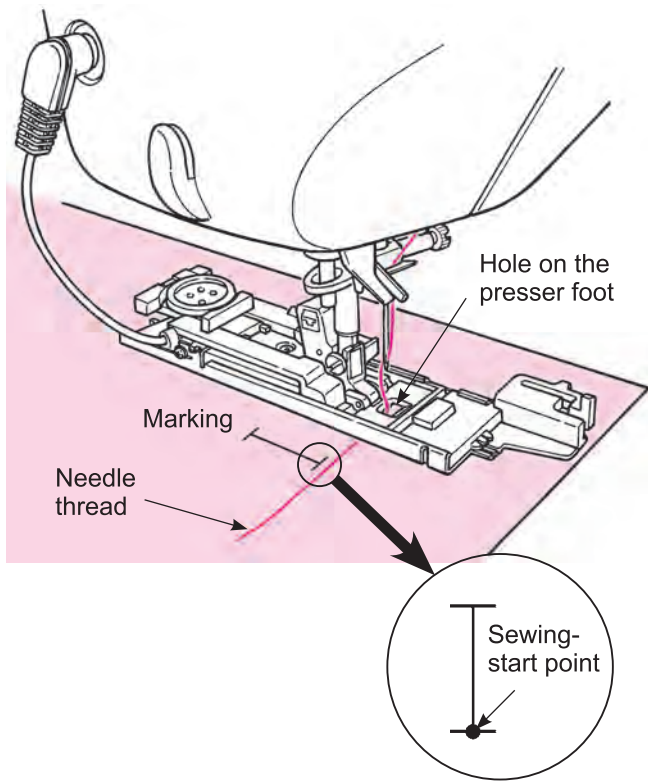

4 Place the fabric under the presser foot.

Raise the presser foot, pass the needle thread through the hole on the presser foot and pull it out sideways. Place the fabric under the presser foot, align the marking with the sewing-start point. Penetrate the needle into the fabric by turning the hand wheel and lower the presser foot.

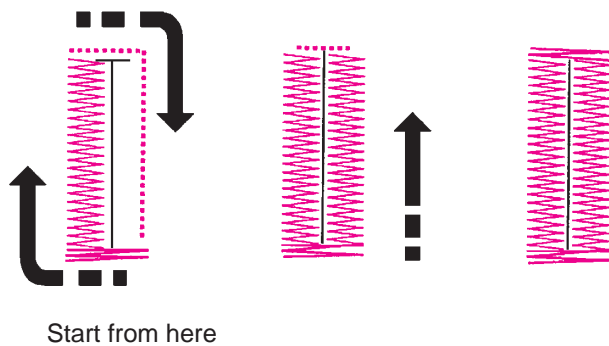

Start from here

5 Start sewing.

The machine will stop automatically after sewing the buttonhole.

- * If a buttonhole of the same size will be sewn again, push the thread trimming button to trim the threads and raise the presser foot. Under this condition move to another point, lower the presser foot and then start sewing.
- * Do not change stitch length and/or zigzag width during buttonholing. Otherwise this will cause imbalanced stitches.
- * If thread trimming button is pushed while sewing buttonhole, the machine will stop and will not complete the buttonhole.
- * Depending on material to be sewn and weaving direction of the material, there might be a slight difference in zigzag widths between right and left lines of buttonholes. Test sewing is recommended.

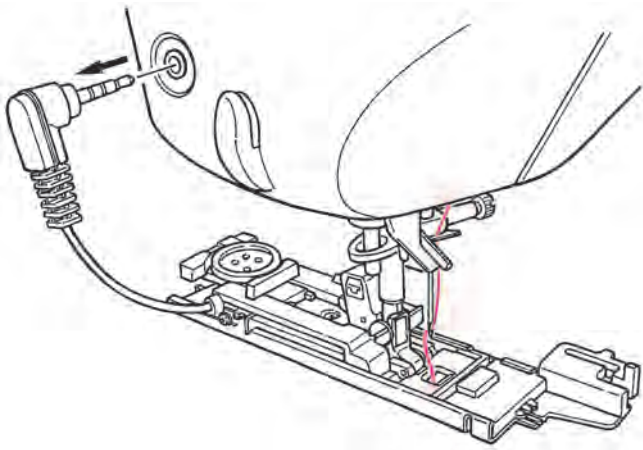

6 Unplug the sensor pin after sewing.

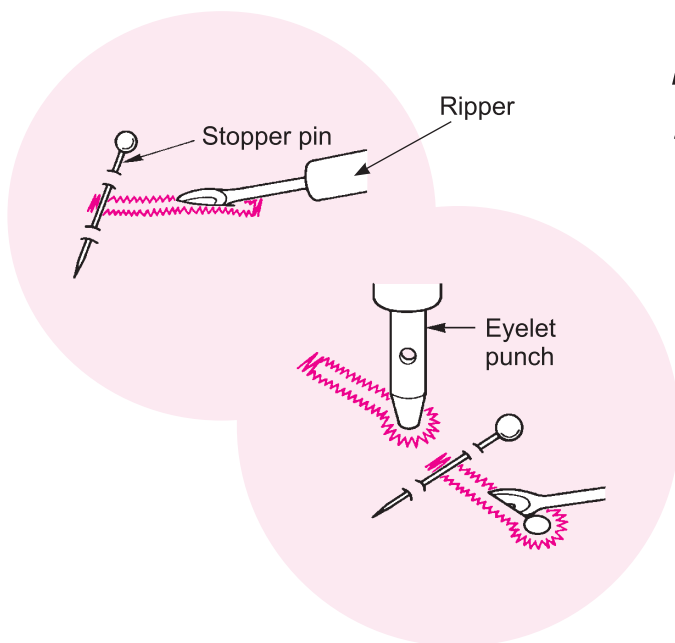

7 Opening the buttonhole using a ripper.

[double bartack]

Pierce a stopper pin at the bartack and open the buttonhole with a ripper. Be careful not to cut the stitches.

[Keyhole buttonhole]

Place a cardboard under the buttonhole and make a hole with the eyelet punch. Then pierce a stopper pin at the bartack and open the buttonhole with a ripper.

● Buttonhole clamping plate

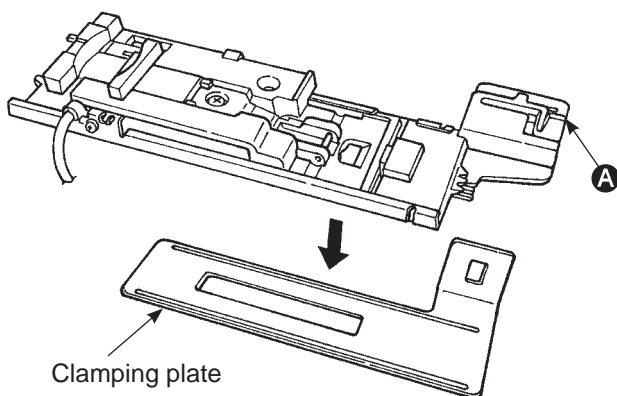

Caution

Turn off the power switch before setting the clamping plate.

It will be easier to sew buttonholes on the thin fabrics and/or near the overlapped sections, if the clamping plate is used.

1. Attach the buttonhole presser foot to the presser foot holder, with the clamping plate together.
2. Place the fabric between the presser foot and the clamping plate.

* You can remove the clamping plate by holding **A**.

■ Buttonhole with gimp

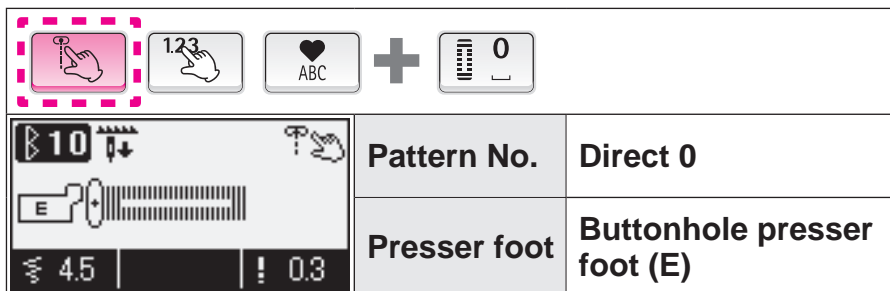

⚠ Attention

Turn OFF the power switch before replacing the presser foot.

Buttonholes with gimp thread prevent the buttonholes from stretching and can make them more secure. Use thread such as hand-sewn buttonholes and similar for gimp thread.

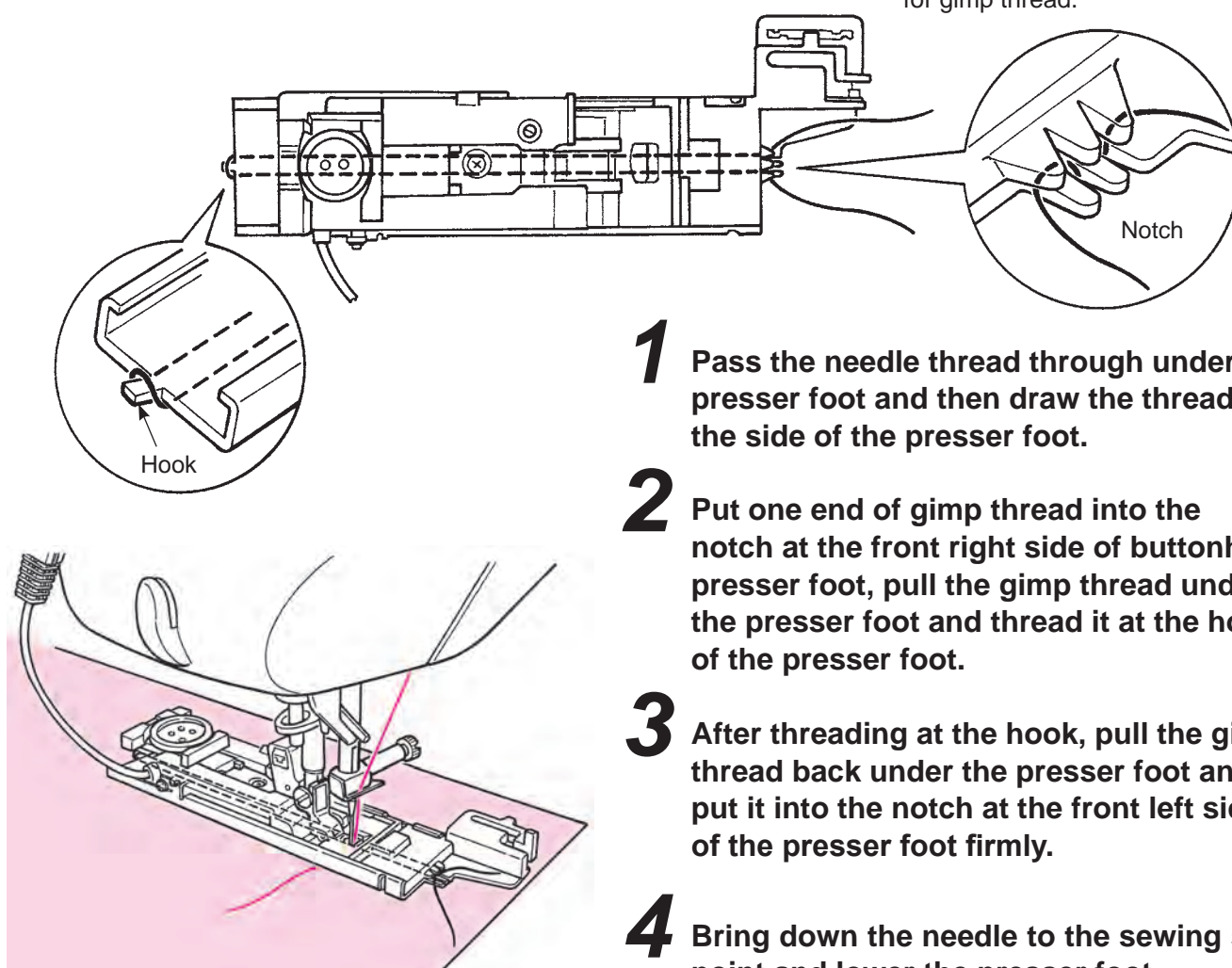

1 Pass the needle thread through under the presser foot and then draw the thread to the side of the presser foot.

2 Put one end of gimp thread into the notch at the front right side of buttonhole presser foot, pull the gimp thread under the presser foot and thread it at the hook of the presser foot.

3 After threading at the hook, pull the gimp thread back under the presser foot and put it into the notch at the front left side of the presser foot firmly.

4 Bring down the needle to the sewing start point and lower the presser foot.

5 Sew the buttonhole.

6 Pull the left gimp thread to take off slack and cut excess gimp thread.

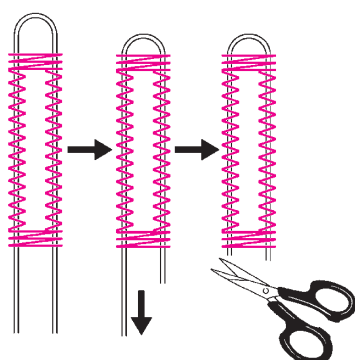

■ When changing the width of the buttonhole

Turn the zigzag width adjusting dial/button.

* The setting of the buttonhole width and stitch length will be cancelled when the power is shut down or another pattern is selected.

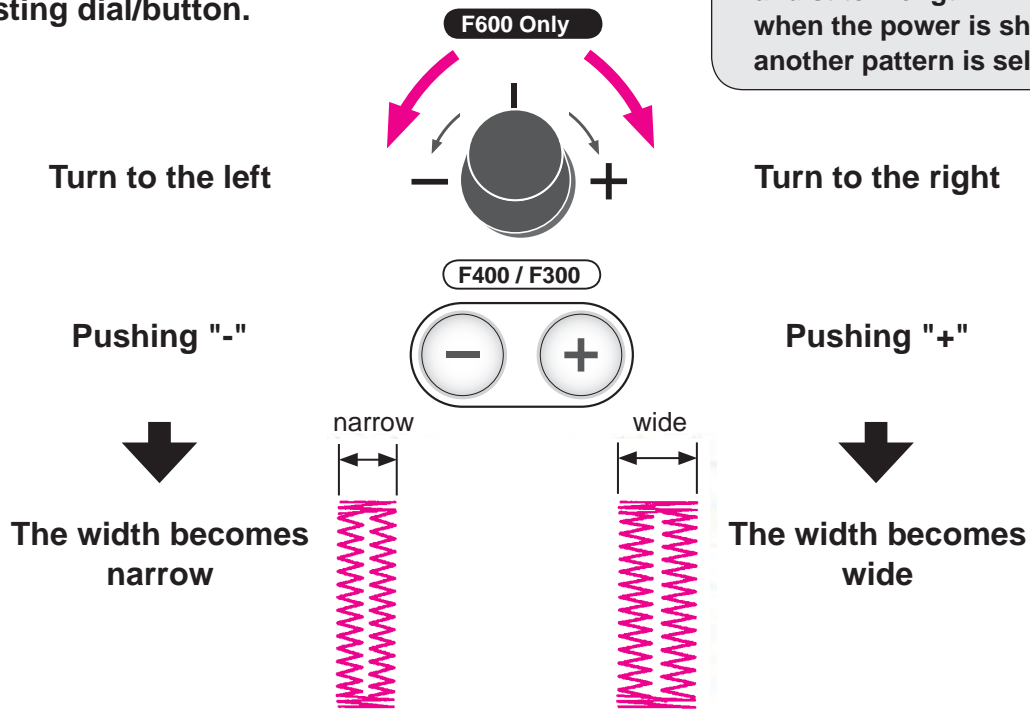

■ When changing the density of the seam

Turn the stitch length adjusting dial/button.

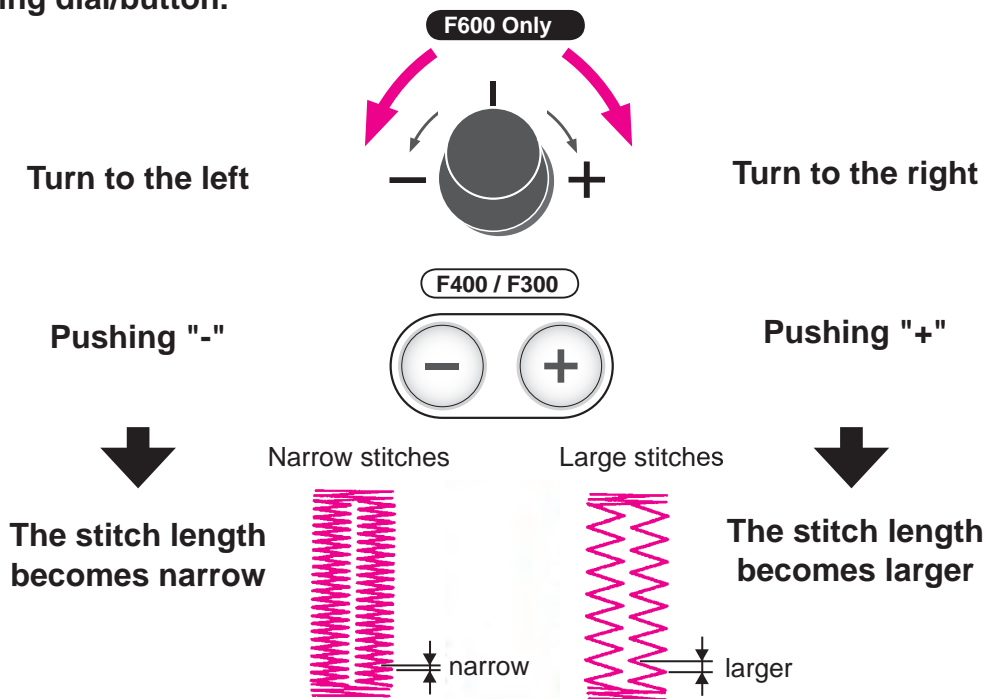

* The width of buttonhole can be changed by () option. (Refer to page 80)

Manual 2-step buttonhole

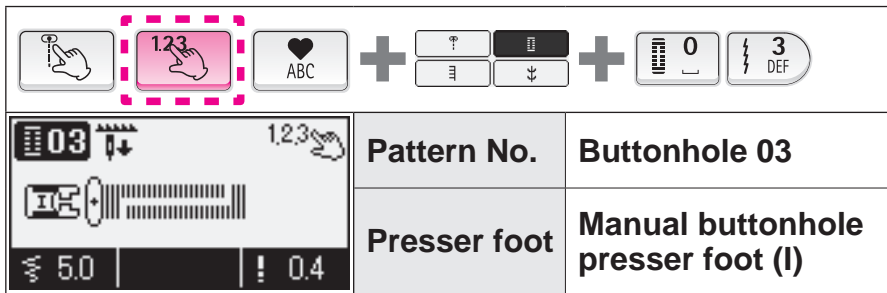

⚠ Attention

Turn OFF the power switch before replacing the presser foot.

* Turn the “zigzag width” and “stitch length” adjusting dials before sewing when you want to change the buttonhole width and density of the seam.

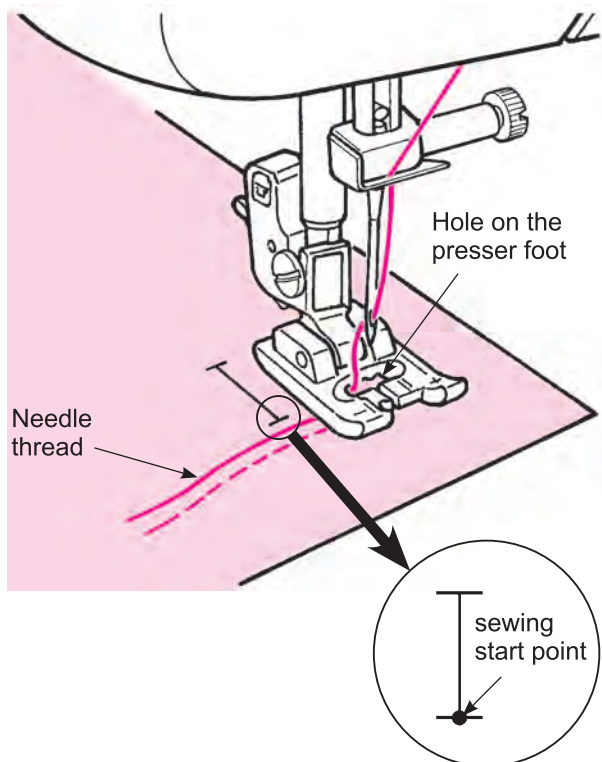

1 Set the manual buttonhole presser foot (I).

2 Pass the needle thread through the hole of the presser foot and pull it out sideways together.

3 Bring down the needle on the sewing start point and lower the presser foot.

4 Push start/stop button to sew.

* At this time, if the start/stop button is pushed, the machine will stop sewing. And if the start/stop button is pushed again, then the machine will continue to sew the left side of the buttonhole.

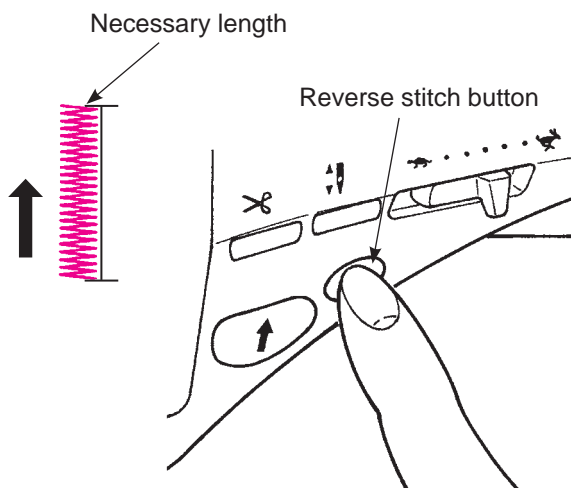

Push the reverse stitch button when it reaches the necessary length of the left side of the buttonhole.

Sew bartack and the right side of the buttonhole, then the machine sews bartack and right side of the buttonhole.

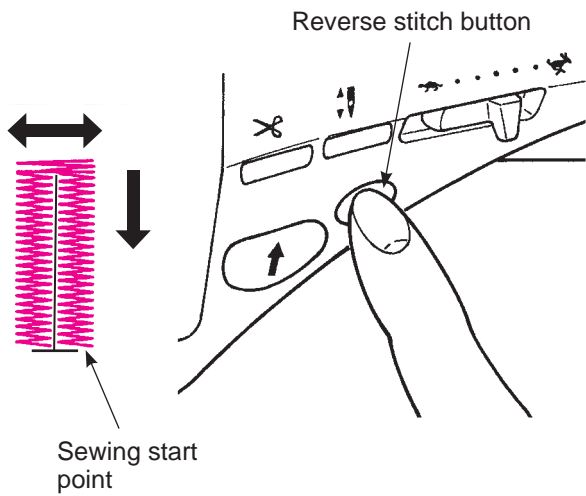

5 Push reverse stitch button when it comes to the sewing start point.

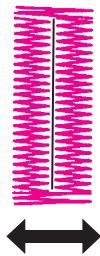

6 Sew bartack and lock stitches until the machine stops automatically.

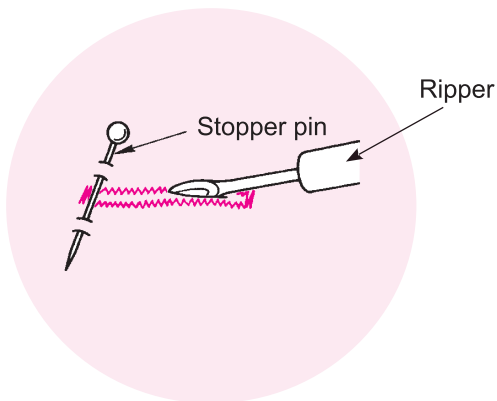







7 Pierce a stopper pin at the bartack and open the buttonhole with a ripper. Be careful not to cut the stitches.

As the numbers of stitches of both right and left lines of buttonhole is memorized in the sewing machine, the buttonhole of the same size can be sewn.

* If you want to change the memory, select the stitch pattern once again.

* In the case of a 2-step buttonhole, sewing direction of the left and that of the right side is different. Due to this and according to fabrics to be sewn, it may be possible that the density of each side looks different.

Bartacking

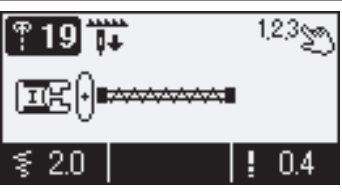
			+		+		
		Pattern No. Practical 19 F600 Practical 17 F400 / F300	Presser foot Manual buttonhole presser foot (I)				

Attention

Turn OFF the power switch before replacing the presser foot.

Bartacking is used to reinforce the part of the seam that is likely to ravel.

* The length of the bartack is determined by pushing the reverse stitch button, but it will automatically make a u-turn when it reaches the maximum of 20 stitches.

* If the presser foot cannot be parallel to throat plate, use filler fabric or cardboard.

■ example of use

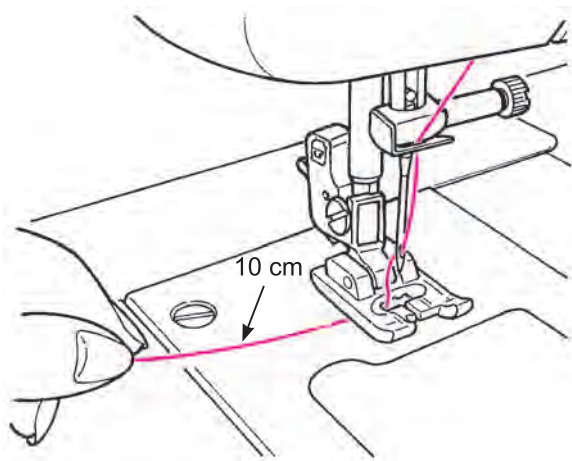
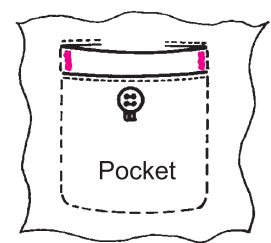

1 Pass the needle thread through the presser foot.

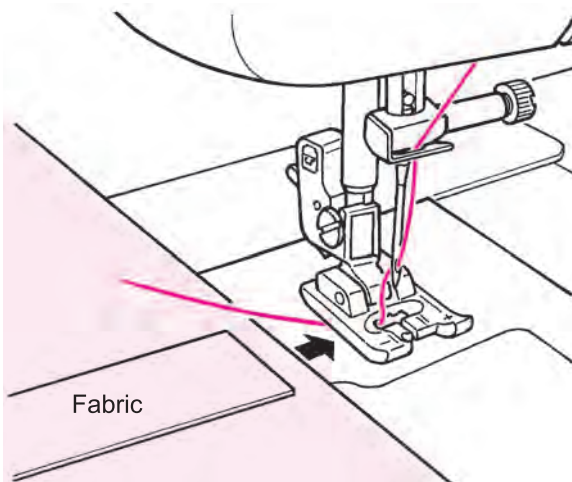

2 Place the fabric under the presser foot.

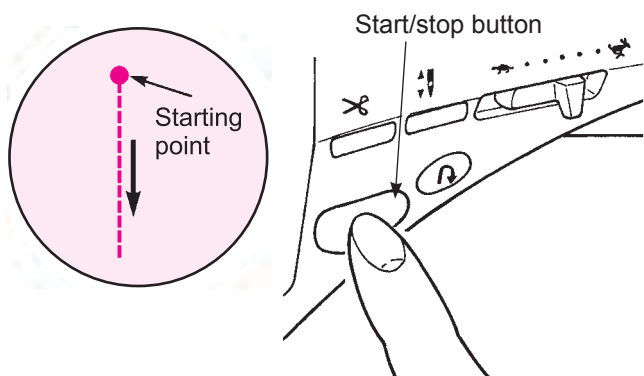

3 Start sewing.

Push the start/stop button and the machine starts to sew straight stitches.

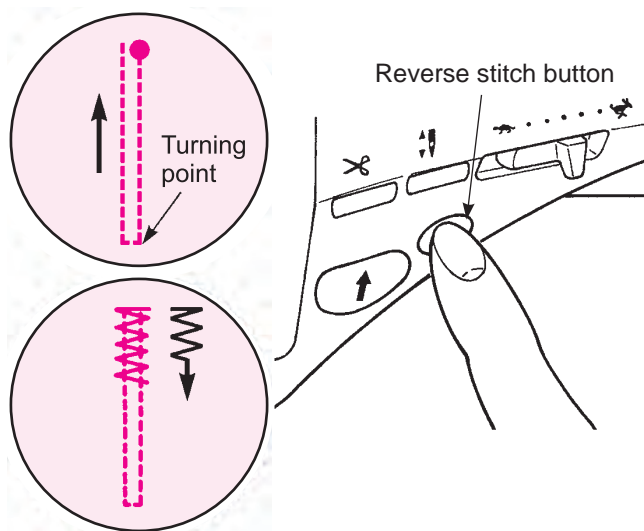

4 When it comes to the turning point push the reverse stitch button.

The machine goes back to the starting point by sewing straight stitches and then it sews zigzag stitches to the point where the reverse stitch button is pushed.

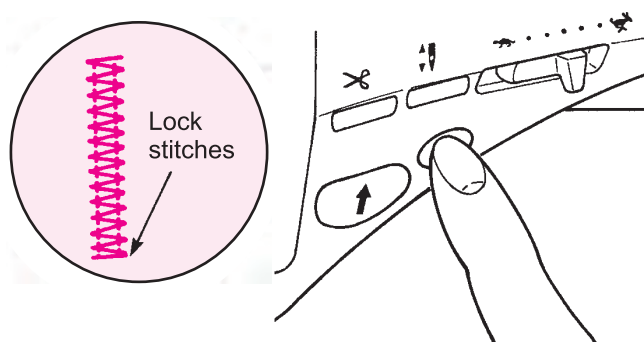

5 When the machine comes to the sewing end point, push the reverse stitch button.

The machine sews lock stitches and stops.

**To sew a bartack of the same length again...
when the length of the first bartack has been memorized,**

- When the start/stop button is pushed, the machine starts to sew and makes a u-turn automatically at the same point as the first bartack.

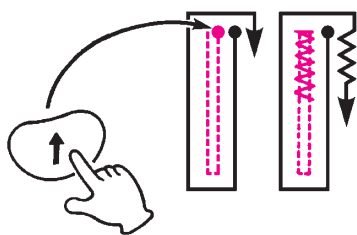

- When it comes to the sewing end point, push the reverse stitch button.

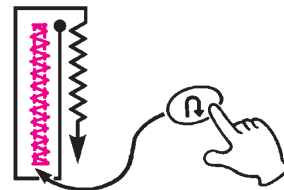

* If you want to change the memorized length of the bar tack, please select stitch pattern again.

Inserting zippers

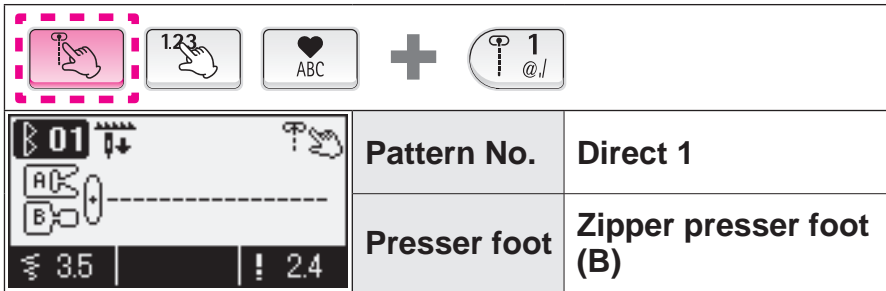

⚠ Attention

Turn OFF the power switch before replacing the presser foot.

Zippers are set in two different ways: by inserting into the side seam of the garment and by centering in position.

* **Make sure to use center needle position (Stitch pattern No. Direct 1).**

■ Preparation before attaching zipper

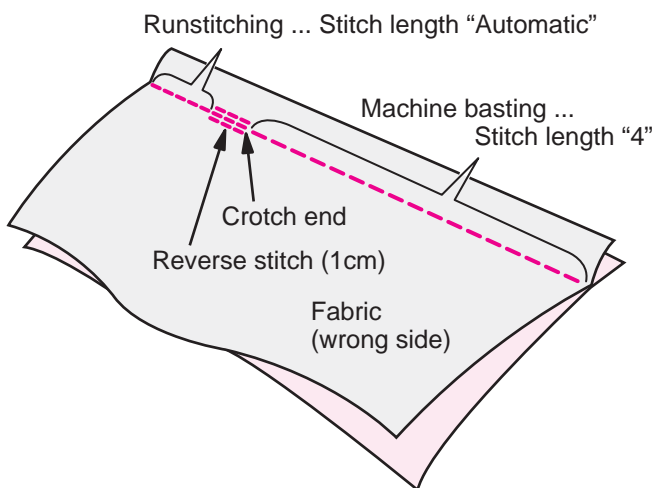

1 Use the standard presser foot (A) to sew.

Place the fabrics face-to-face. Check the runstitching length and the length of the zipper to be inserted. Machine baste the zipper onto the fabrics.

Machine basting = zipper opening length + 1 cm

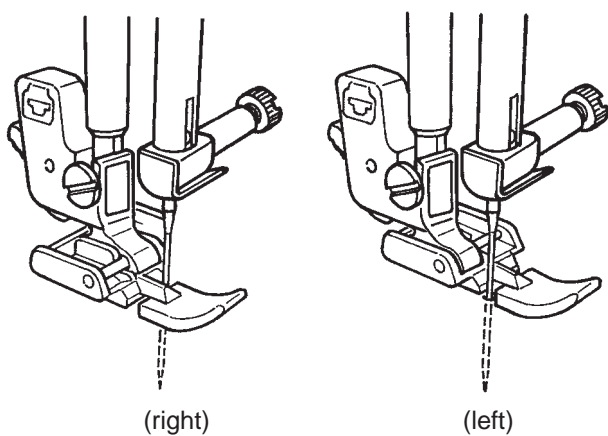

2 Attach the zipper presser foot (B) to the machine.

When sewing the left side of the zipper, place the zipper under the right portion of the zipper presser foot. When sewing the right side of the zipper, place the zipper under the left portion of the foot.

■ Lapped insertion

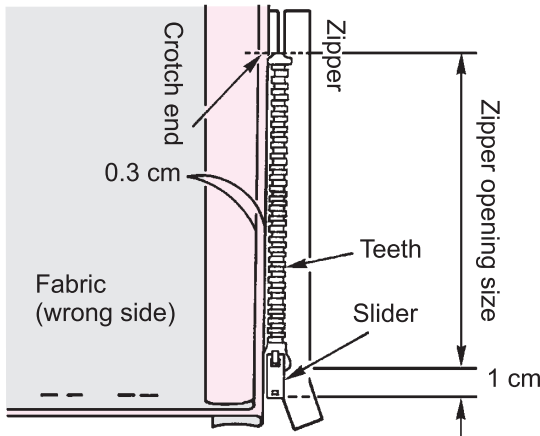

1 Open the seam allowance.

Neatly open the seam allowance. Adjust the back seam allowance so that it projects 3 mm from the seam. Press with an iron to make a crease. Fit the crease along the edge of the teeth.

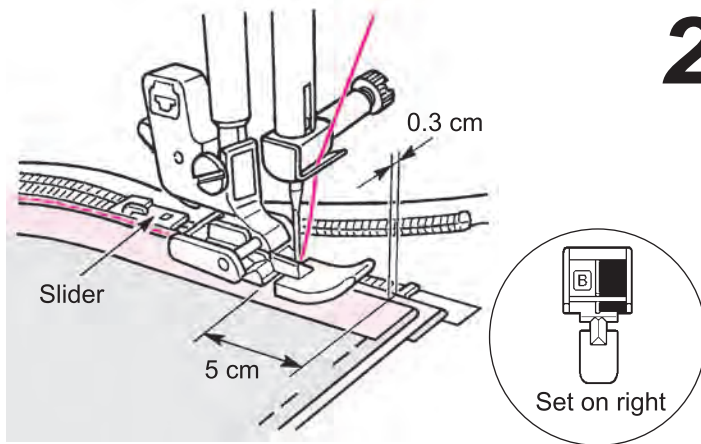

2 Sew the zipper tape on the seam allowance from bottom to top.

Fitting the edge of the zipper presser foot along the edge of the zipper teeth, sew the zipper tape on the seam allowance. At the slider part of the zipper, stop the machine at 5 cm (2 inches) before the slider. Move the slider to the far side of the presser foot and sew the zipper until its top end is reached.

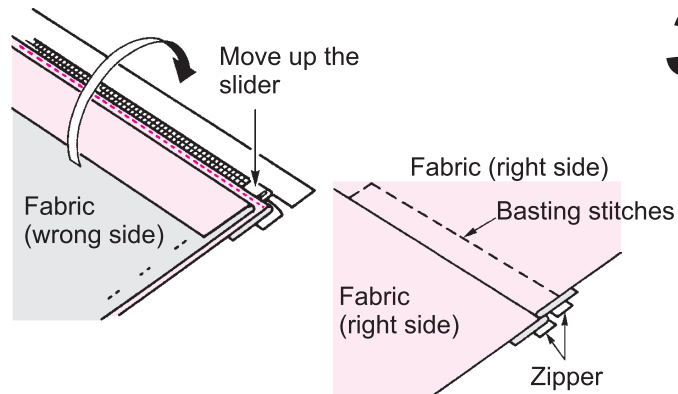

3 Put the fabric over the zipper. Baste the zipper and set it on the fabric.

* Baste the zipper tape with the fabric with hand basting stitches.

Move the slider to the top of the zipper. Put the fabric over the zipper and perform basting.

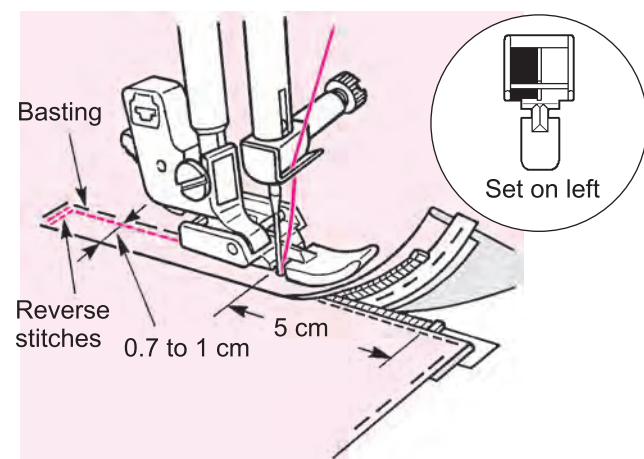

4 Sew reverse stitches and sew the right-hand side.

After sewing reverse stitches, set the left hand side of the zipper presser foot to the zipper teeth. Sew until 5 cm (2 inches) of the zipper end. Undo the basting stitches and move the slider to the far end of the presser foot. Then sew the rest of the way.

■ Centered insertion

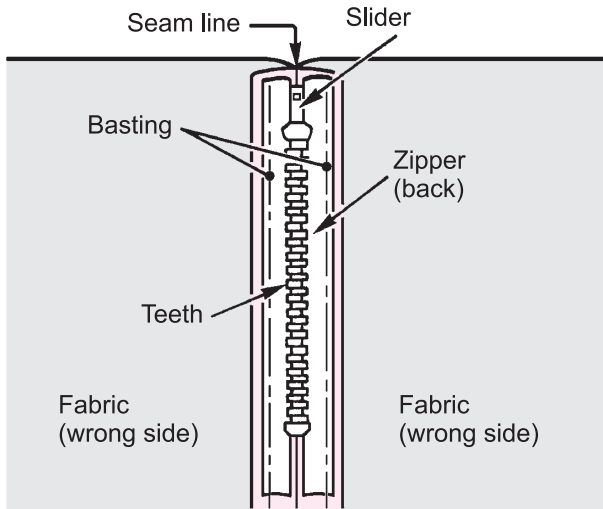

1 Baste zipper and garment body.

Open the seam allowance. Fit the teeth of the zipper at the end of the seam line and perform basting by hand. Pull the slider tab to the up side.

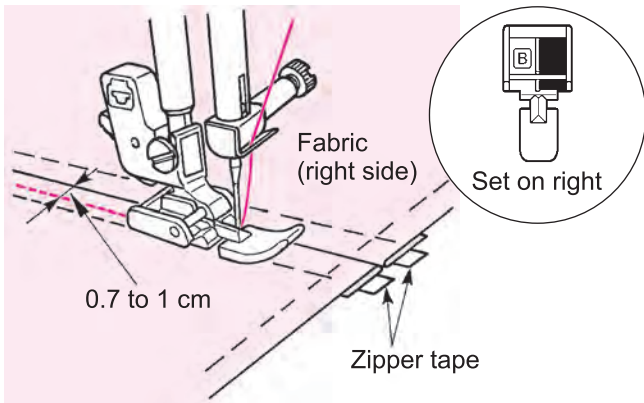

2 Sew the left part of the zipper on the seam allowance from the bottom of the opening to the top.

Sew 0.7 to 1 cm from the seam line.

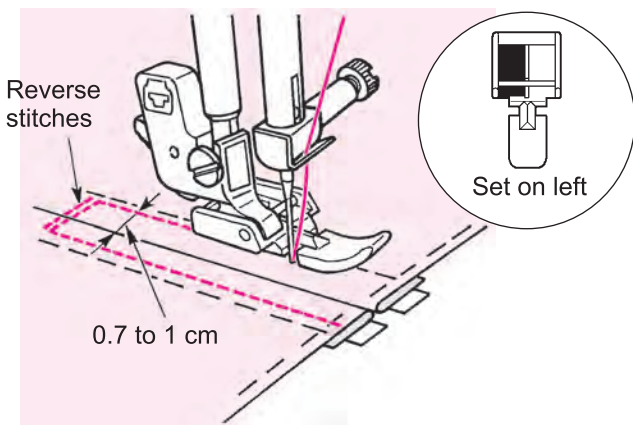

3 Sew the right part of the zipper.

Sew reverse stitches a few times. Sew the other side 0.7 to 1 cm from the seam line.

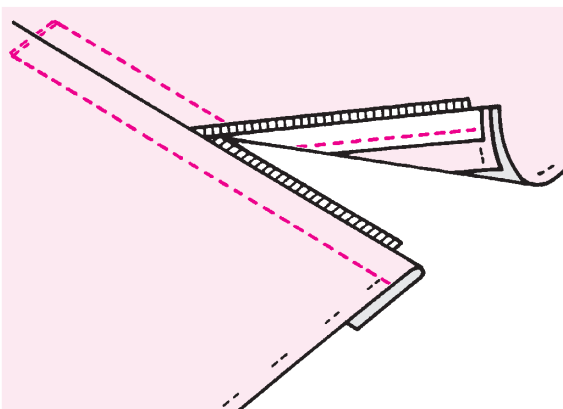

4 Undo only the basting stitches.

Shirring and gathering

	<table border="1"> <tr> <td>Pattern No.</td> <td>Direct 1</td> </tr> <tr> <td>Presser foot</td> <td>Standard presser foot (A)</td> </tr> </table>	Pattern No.	Direct 1	Presser foot	Standard presser foot (A)
Pattern No.	Direct 1				
Presser foot	Standard presser foot (A)				

Attention

Turn OFF the power switch before replacing the presser foot.

- ★ Shirring: such as the shoulder line and waist of the skirt, on which shirring is not seen.
- ★ Gathering: such as shoulder joining and the frills of a skirt.

Gathering

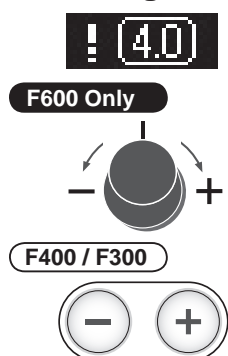

Loose

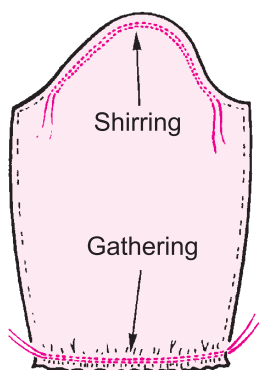
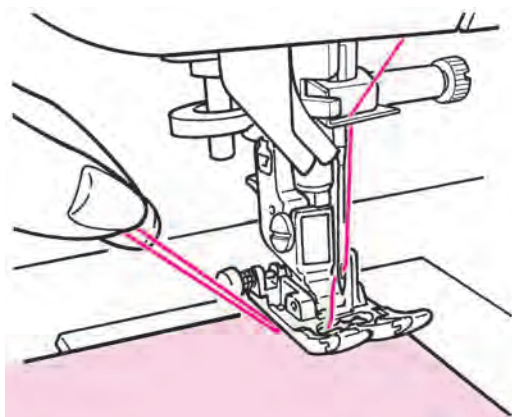
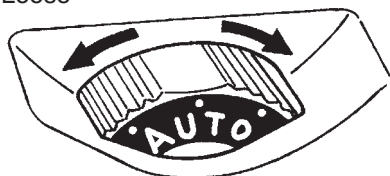

Shirring

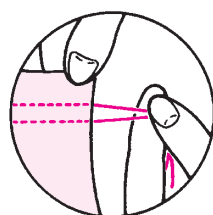
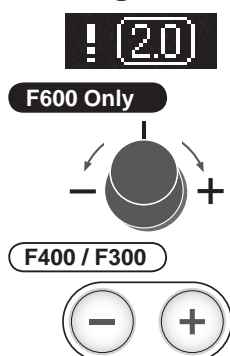

1 Change the stitch length.

Set 3.0 - 4.0 for gathering and 1.5 - 2.0 for shirring.

2 Loosen the needle thread tension.

3 Start sewing.

Leave about 5 cm of needle and bobbin threads both at the sewing start and at the sewing end and sew a parallel line.

4 Pull the lower thread by hand to shrink the fabrics

Pintucking

	Pattern No. Direct 1 Presser foot Standard presser foot (A)

⚠ Attention
 Turn OFF the power switch before replacing the presser foot.

This stitch is used to sew decorations on the front of blouses and/or aprons, etc.

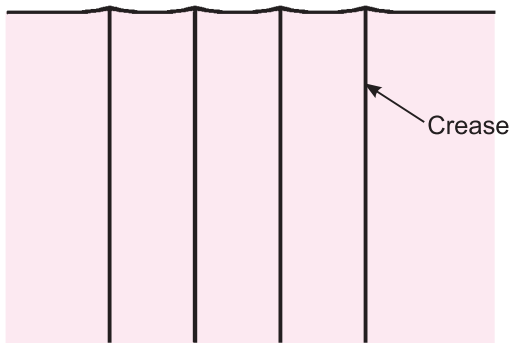

1 Iron the creases of the pintuck.

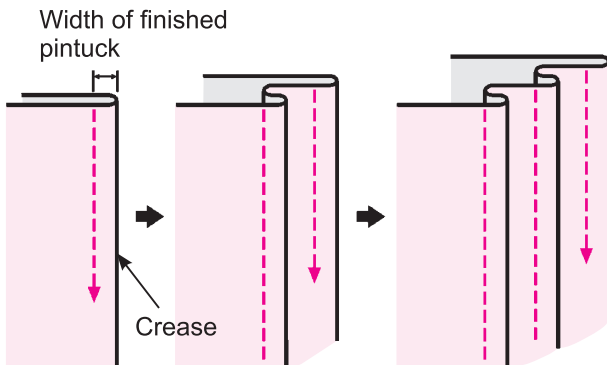

2 Sew the creases one by one and avoid it stretching.

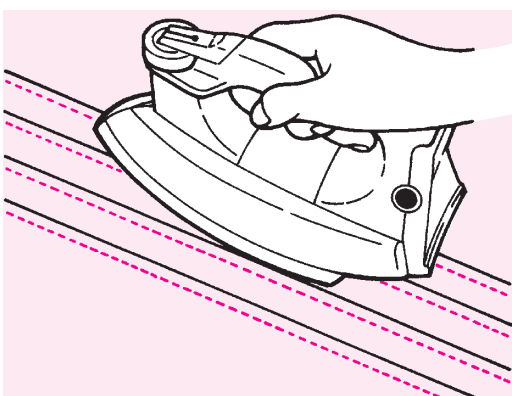

3 After sewing, turn over pintucks and iron them.

■ Example of use

● Blouse



● Apron

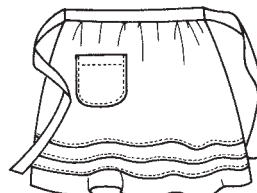

Welt seam

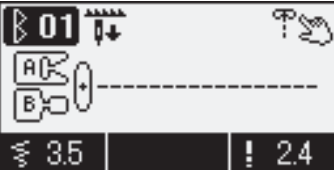
	
	Pattern No. Direct 1 Presser foot Standard presser foot (A)

Attention

Turn OFF the power switch before replacing the presser foot.

This stitch is used for securing an edge.

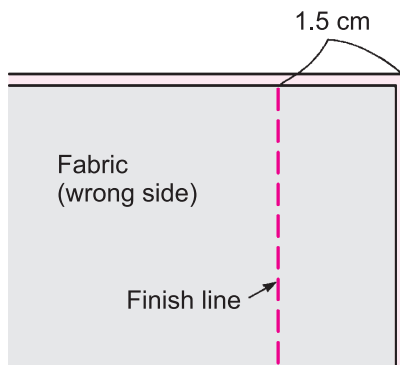

1 Put the fabrics together and sew.

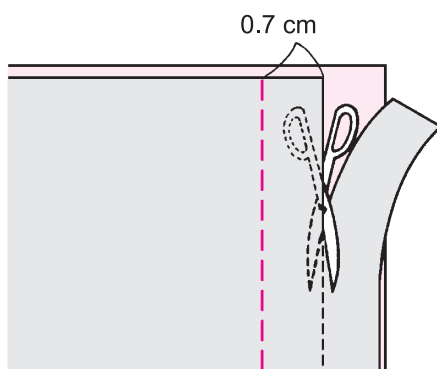

2 Cut half of the seam allowance.

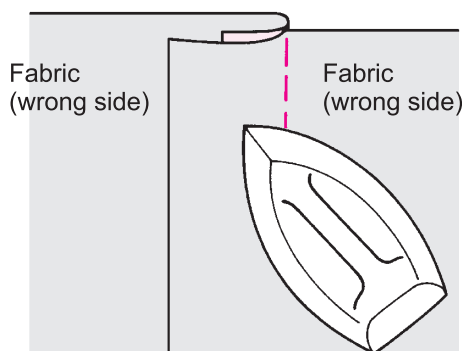

3 Open the fabrics from the finish line and fold the seam allowance together and iron.

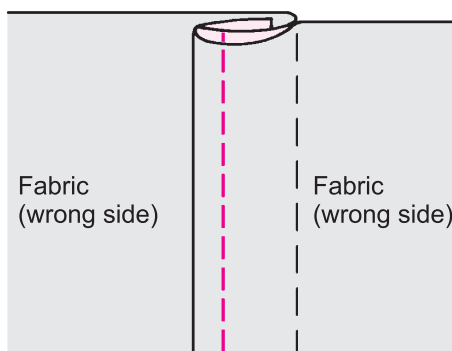

4 Wrap up the shorter seam allowance with the longer one and sew the edge of the crease.

How to use the quilt guide

	Pattern No. Direct 1, 4 Presser foot Standard presser foot (A)

Attention

Turn OFF the power switch before replacing the presser foot.

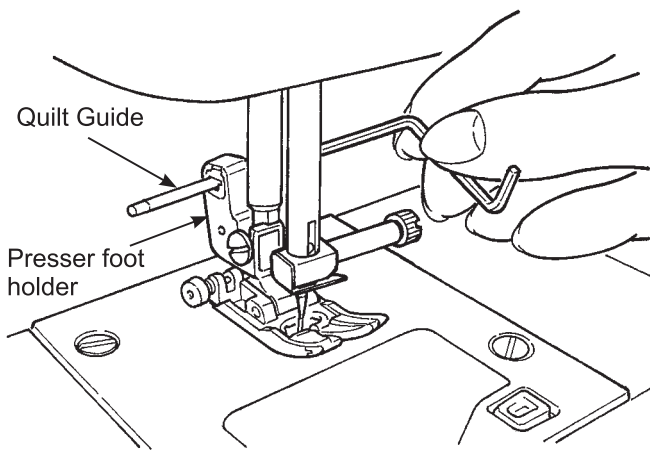



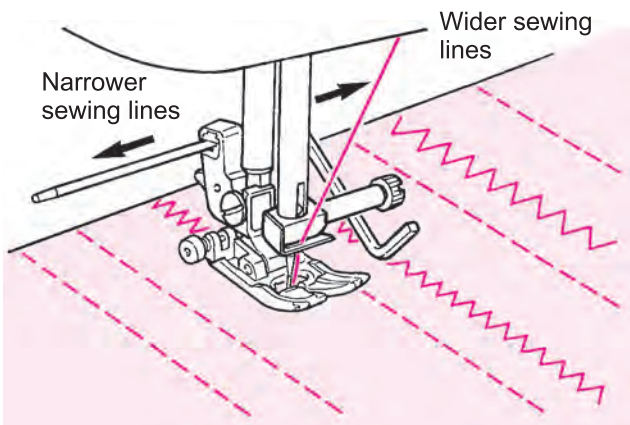



1 Insert the quilt guide into the groove of the presser foot holder.

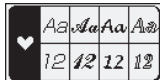

2 Sew while tracing the stitches with the tip of the quilt guide.

Distance between sewing lines can be adjusted freely.

Scallop stitches

			+		+		
		Pattern No. One point 24, 25 F600 One point 24 F400 One point 13 F300	Presser foot Manual buttonhole presser foot (I)				

Attention

Turn OFF the power switch before replacing the presser foot.

This stitch is used for decorating edging on items such as table cloths, collars on blouse, etc.

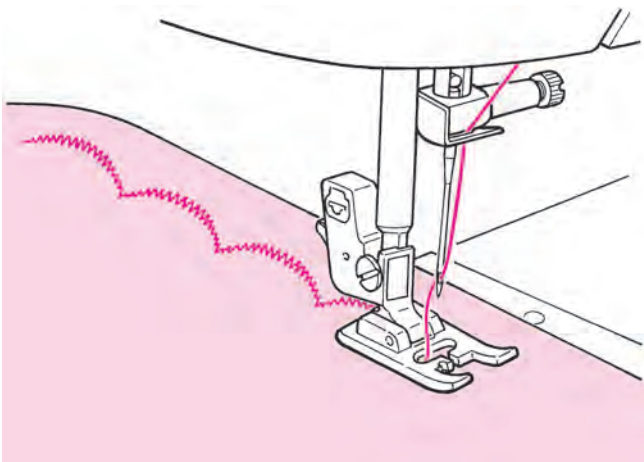

1 To keep the pattern intact, leave some margin and sew on the edge of the cloth.

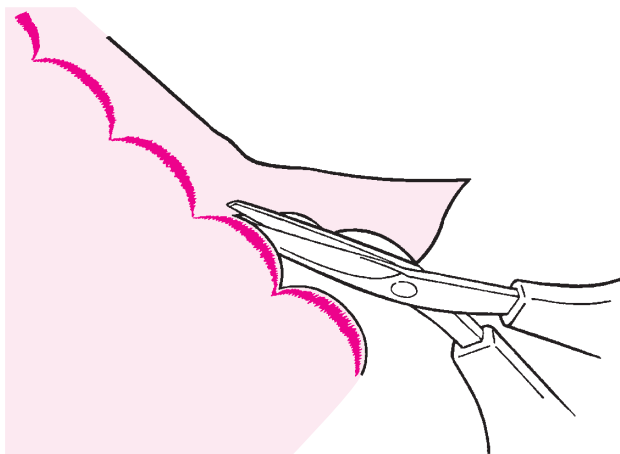

2 Cut the sewn fabric carefully so that stitches are not cut by the scissors.

* Adjust stitch length of the decorative stitches according to the fabric to be sewn.
Sewing on fabric too thick may cause jamming.

Decorative stitches

			+			+		
		Pattern No. Decorative 01~72 F600 Decorative 01~49 F400 Decorative 01~20 F300	Presser foot Manual buttonhole presser foot (I)					

⚠ Attention

Turn OFF the power switch before replacing the presser foot.

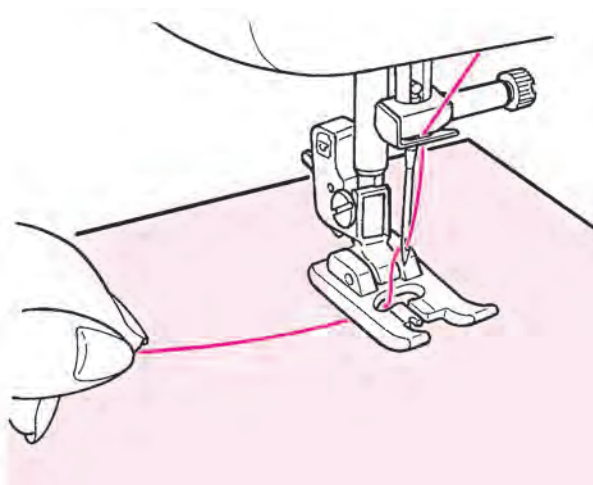

Place the fabric under the presser foot and start.

■ Display of the length of one cycle

Although the length of one cycle of the decorative pattern is displayed, treat it only as a reference, as this will be changeable based on fabric and thread.

Example) 's

5.8 mm

The length of one cycle is displayed.

Patchwork piecing

	<table border="1"> <tr> <td>Pattern No.</td> <td>Direct 2</td> </tr> <tr> <td>Presser foot</td> <td>Standard presser foot (A)</td> </tr> </table>	Pattern No.	Direct 2	Presser foot	Standard presser foot (A)
Pattern No.	Direct 2				
Presser foot	Standard presser foot (A)				

Attention

Turn OFF the power switch before replacing the presser foot.

To sew pieces of cloth together is called piecing in patchwork. When piecing, the seam allowance is usually 1/4" (6.4 mm).

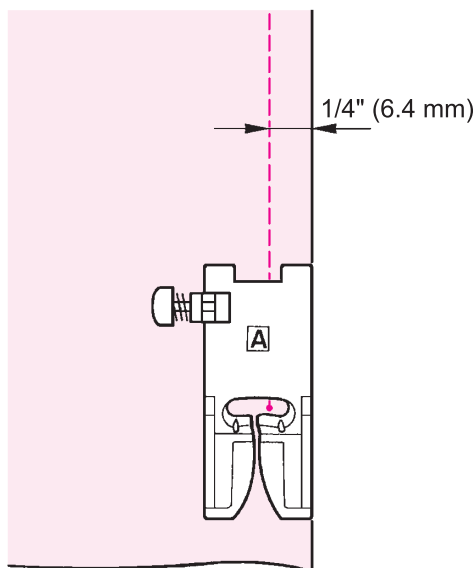

1 Cut the fabric with seam allowance.

2 Align the right end of the presser foot and the edge of the fabric and sew.

The needle will enter 1/4" (6.4 mm) from the edge of the fabric, so the seam allowance of 1/4" (6.4 mm) can be sewn.

The needle position can be adjusted between 0.0~7.0.

When the needle position is at '5.6', the needle is 1/4" (6.4 mm) from the right edge of standard presser foot (A).

* You can change the needle position as you like.
Needle position change: Refer to page 81

Applique (1)

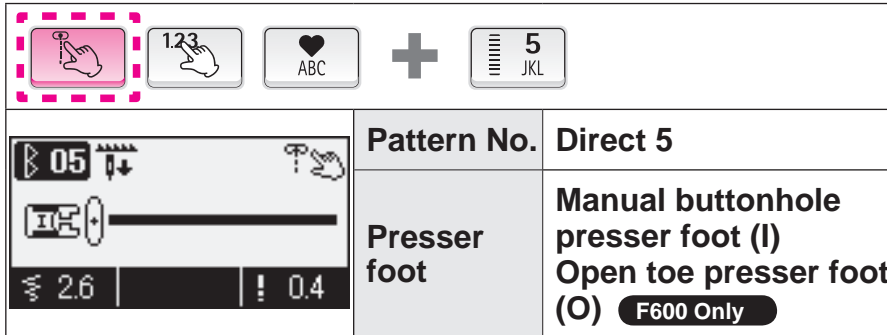

Attention

Turn OFF the power switch before replacing the presser foot.

The edge of the applique fabric is sewn with a compact zigzag, so it is suitable for the applique of cut fabric.

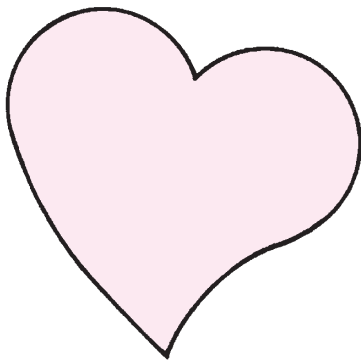

- 1 Cut the applique fabric at the finish line, put it on the base fabric and fix it temporarily.**

It is recommended to use both-sided adhesive interlining or the similar to fix the appliqué fabric on the base fabric. Use the interlining to the edge of the appliqué fabric.

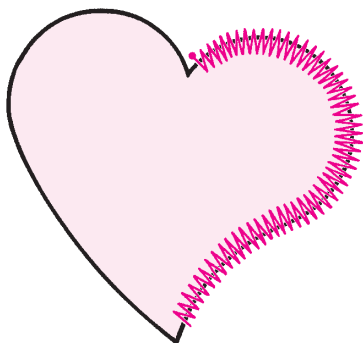

- 2 Turn the hand wheel towards you and start sewing along with the outer side of the applique fabric.**

When you start sewing, the machine will automatically sew 3 lock stitches.

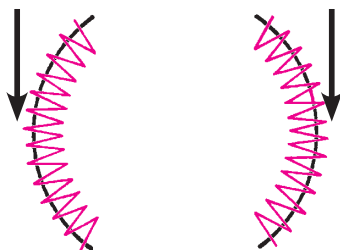

* When sewing steep angles, keep the needle inside the fabric, raise the presser foot, change sewing direction and sew slowly.

Keep the needle inside the fabric at the point of arrow and raise the presser foot.

- 3 At the end of sewing, push the reverse stitch button to sew lock stitches for 3~5 stitches.**

* Usually center needle position is used for appliqué stitches but right or left needle position can be used. Changing needle position: Refer to page 81

Applique (2)

	Pattern No. Direct 6 Quilting 01~04, 35~37 F600 Quilting 01~04, 07, 08 F400/F300
	Presser foot Manual buttonhole presser foot (I) Open toe presser foot (O) F600 Only

Attention

Turn OFF the power switch before replacing the presser foot.

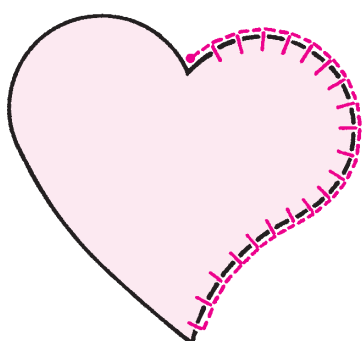
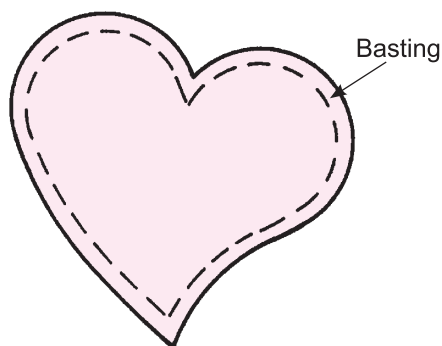
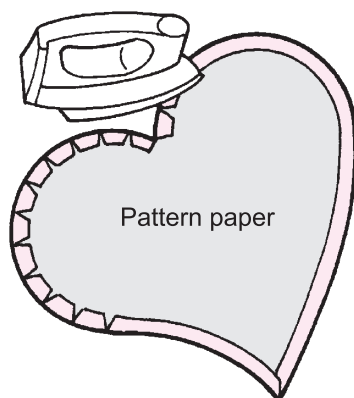
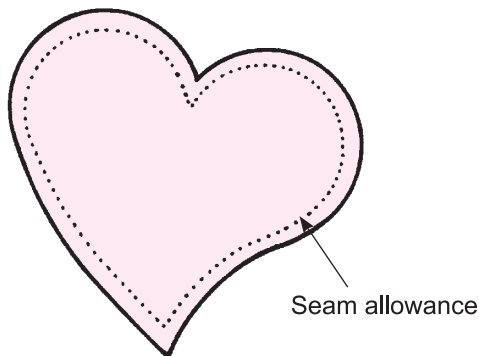

To make the stitch inconspicuous, an applique can be sewn.

- 1** Cut the applique fabric with seam allowance of 3~5mm.
- 2** Put the pattern paper onto the wrong side of the fabric and fold the seam allowance at the finish line.
- 3** Put the applique fabric on the base fabric. Temporarily fix it with basting stitches or glue.
- 4** Turn the hand wheel towards you and start sewing along with the outer side of the applique fabric.
 When you start sewing, the machine will automatically sew 3 lock stitches.
 * When sewing steep angles, keep the needle inside the fabric, raise the presser foot, change sewing direction and sew slowly.
- 5** Lock stitch at the end of sewing.

Push the reverse stitch button and the machine will automatically sew 3 lock stitches.

It is better to lock stitch at the outer side of the applique fabric.

* Usually center needle position is used for appliqué stitches but right or left needle position can be used. Changing needle position: Refer to page 81

Crazy quilt

			+			+	Pattern number
		Pattern No. Quilting 01~67 F600 Quilting 01~29 F400 Quilting 01~22 F300	Presser foot Manual buttonhole presser foot (I)				

Attention

Turn OFF the power switch before replacing the presser foot.

Using a decorative stitch, this gives a decorative look to the joining of patchworks. It is recommended to use decorative thread such as embroidery thread.

Example 1) Quilting 08

Sew patterns so that they extend over both pieces of fabric.

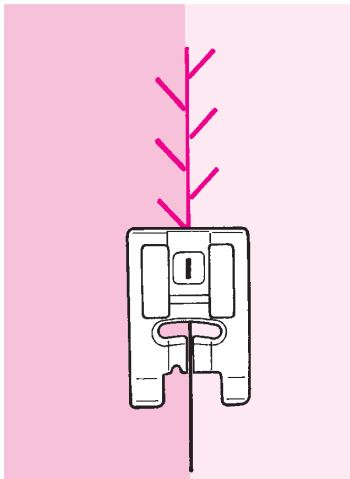

Example 2) Quilting 10

Sew patterns so that the presser foot holds one side of fabric.

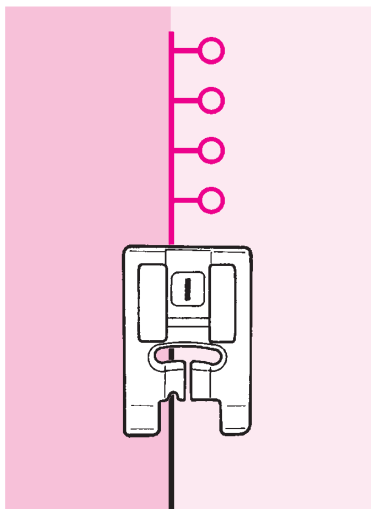

F600 Only

★ Random pattern

Random stitch patterns (Quilting 18~34) are transformations of Quilting 01~17.

The width can be changed automatically by section, so that you can enjoy those patterns.

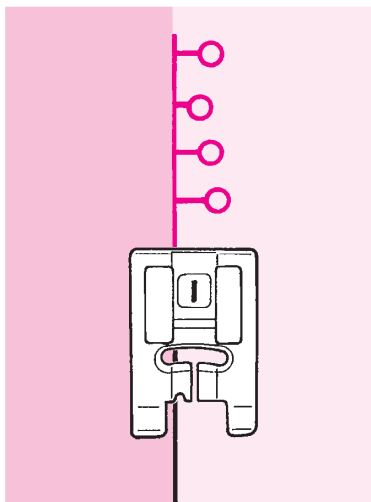

Stitch in ditch quilting

	Pattern No. Direct 1 Presser foot Edge sewing presser foot (R)

⚠ Attention

Turn OFF the power switch before replacing the presser foot.

This is for quilting the edge of patchworks and appliqués. The machine will sew the lower (thinner) side of the fabric layers. As a result, the stitches will not be noticeable and have an effect to make the design look three dimensional or emphasized.

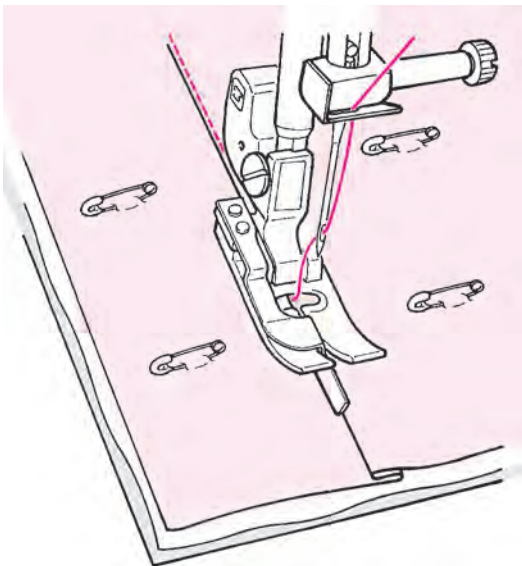

1 Put the top layer of fabric with patchwork and/or appliqués, quilting cotton and bottom layer of fabric together by pin or basting stitches.

2 Put the guide of the presser foot along with the crease and sew.

The needle enters behind the guide, so that the edge of the crease can be sewn.

* If the desired points can not be sewn, adjust the needle position.

Needle position change: refer to page 81

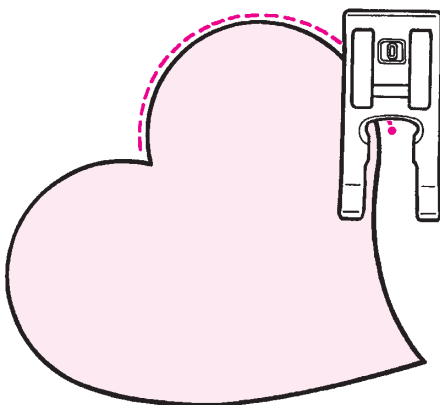

★ Curved concealed quilting

Use manual buttonhole presser foot (I) or the open toe presser foot (O). Sew curves by lifting the presser foot and changing the direction very often.

Also this can be done by free motion with the quilt presser foot. (Refer to page 69.)

Quilting (straight stitch)

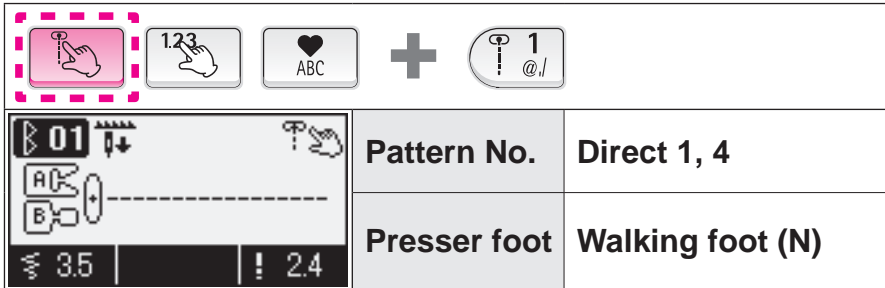

Attention

Turn OFF the power switch before replacing the presser foot.

Quilting is the process of sewing the top layer of fabric, with quilting cotton in between and a bottom layer of fabric underneath.

By using the walking foot, the machine feeds both top and bottom fabrics together at the same time, so fabric shifting is eliminated.

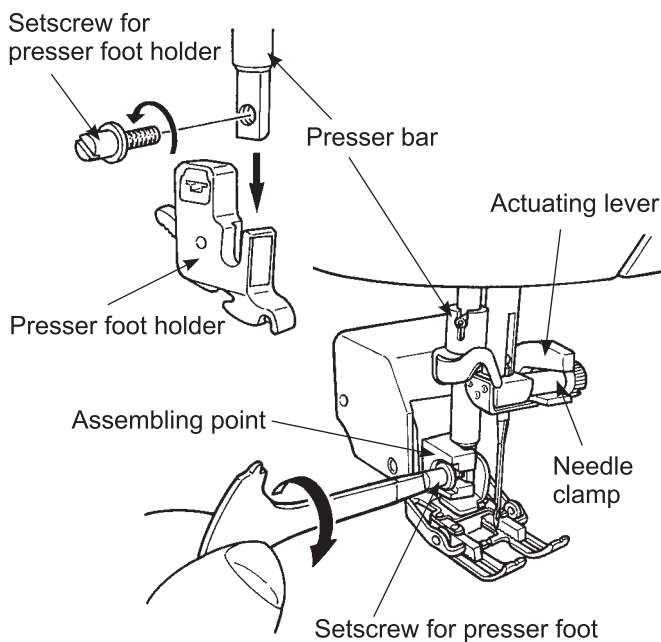

1 Put top layer of fabric with patchwork and/or appliqué, quilting cotton and bottom fabric together by using pin or basting stitches.

2 Assemble the walking foot.

Raise the presser bar. Loosen the setscrew for presser foot holder and remove the presser foot holder. (Refer to page 13)

Set the actuating lever on the needle clamp and insert the assembling point to the presser bar and tighten the setscrew for presser foot.

3 Place your hands to both sides of the presser foot and sew by pulling the fabrics apart.

* Sew with slow to medium sewing speed.

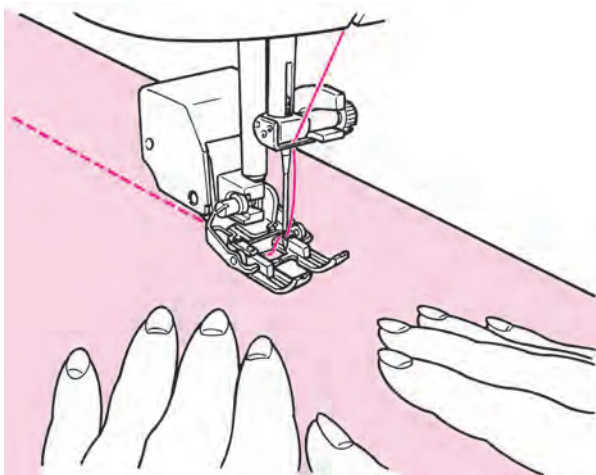

* To further avoid fabric shifts, set the presser foot pressure lower.

Adjustment of presser foot pressure: Refer to page 26

Quilting (free motion)

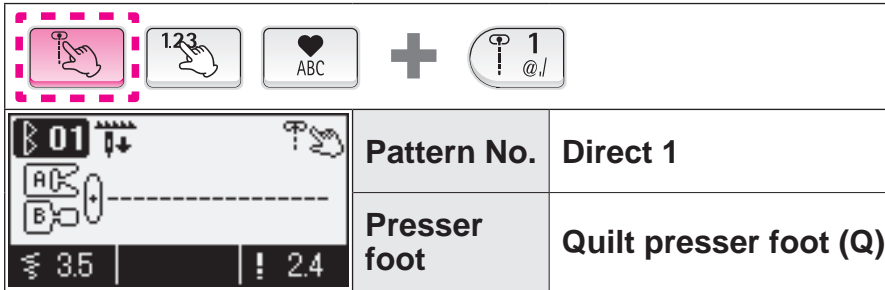

Attention

Turn OFF the power switch before replacing the presser foot.

It is called free motion quilting when moving the fabrics freely towards any directions without using the feed dog of sewing machine.

When the feed dog is lowered (drop feed condition), it is possible to sew various curves and/or any directions by moving the fabrics by hands.

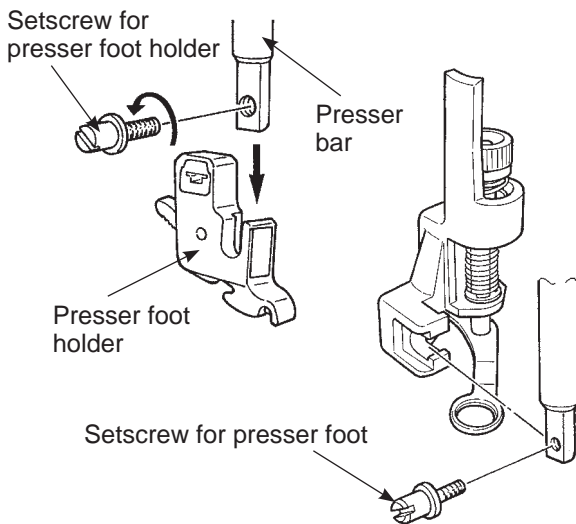

1 Put top layer of fabric with patchwork and/or appliqué, quilting cotton and bottom fabric together by using pin or basting stitches.

2 Assemble the quilt presser foot.

Raise the presser bar. Loosen the setscrew for presser foot holder and remove the presser foot holder. (Refer to page 13)

Set the quilting foot and tighten the setscrew for presser foot.

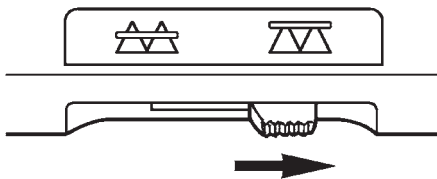

3 Move the drop feed knob to the right hand side.

Feed dog is now down.

4 Place the fabric underneath the presser foot and lower the presser foot.

5 Adjust the height of presser foot according to the thickness of the fabrics by screw. When the height is 1mm from the surface of the fabrics, it will be easier to move the fabrics without interference.

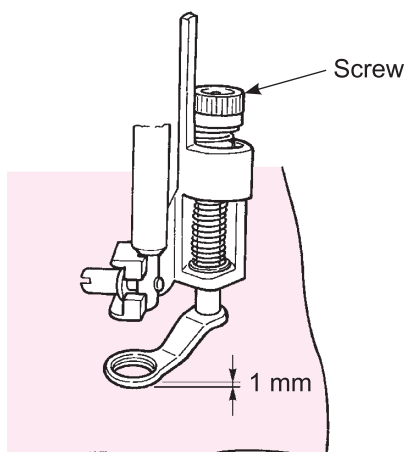

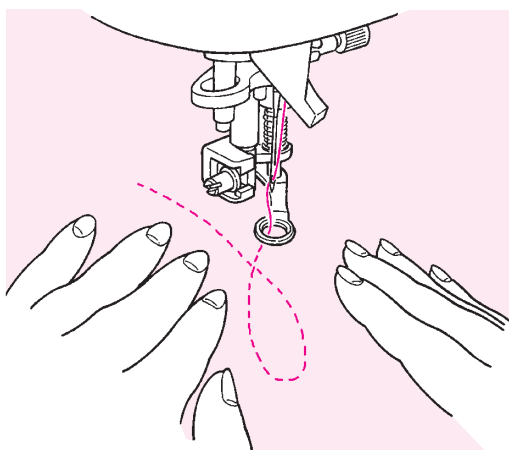

6 Use both hands to hold the fabrics and move it without letting it loose. The target stitch length is about 1.5~2.0mm.

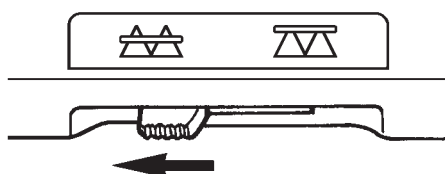

7 When free motion sewing is finished, move the drop feed knob back to the left side.

The feed dog will be up and engaged at the same time as the machine starts to sew.

Tips

● How to lock stitches

1. At sewing start, pull up the bobbin thread on the top layer of the fabric, hold both needle and bobbin threads together and sew 3 stitches on the same point. After that move fabrics as you wish. In this way, stitches on the wrong side of the fabrics look neat.
2. At sewing-end sew 3 stitches on the same point and stop.

● How to sew stitches with the same stitch length

1. When the foot controller is used, the fabrics can be guided by both hands and you can move the fabrics freely.
2. Set the speed controller to medium or medium low first, press the foot controller completely and move the fabrics.
 - if stitches become too large, set the speed controller to "faster"
 - if stitches become too small, set the speed controller to "slower".

☆ When doing the free motion with zigzag stitch, use the quilt presser foot (transparent type) which is optionally available from your dealer.

One-point stitch/sewing letters

			+
F600		Pattern No.	One point 01~38 F600 One point 01~33 F400 One point 01~18 F300 Letters
F400 F300		Presser foot	Manual buttonhole presser foot (I)

Attention

Turn OFF the power switch before replacing the presser foot.

Preparation before sewing

(in order to sew a pattern neatly, apply interlining and conduct a test sewing first.)

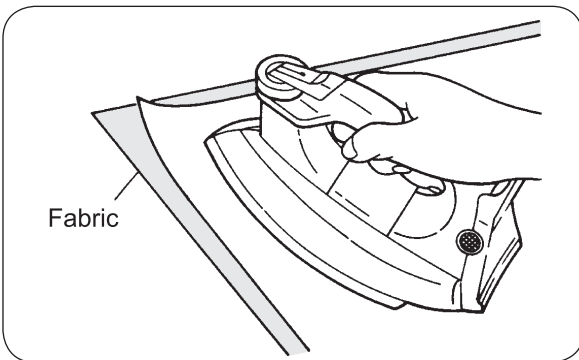

Use an iron to attach a fusible interlining to the wrong side of fabric.

* When stitch length becomes too small, the bobbin thread will come out to the front side of fabric and/or stitches might get stuck. Therefore make sure to conduct a test sewing beforehand.

Test sewing

			+			+		
22		Pattern No.	Practical 22 F600 Practical 20 F400 / F300					
		Presser foot	Manual buttonhole presser foot (I)					

Since the pattern might be deformed according to the type and thickness of fabric and fusible interlining to be used, make sure to conduct test sewing on the same fabric and interlining.

Select stitch pattern No. 22 **F600** (No. 20 **F400 / F300**) for test sewing; If the stitch pattern deforms, adjust it by the pattern adjustment dial.

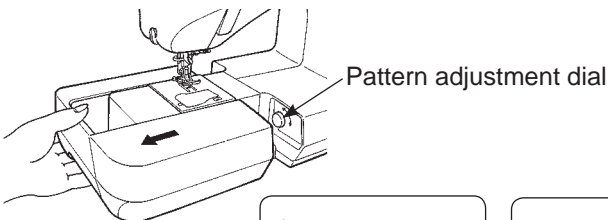

Correct shape



When right side is higher than left side,

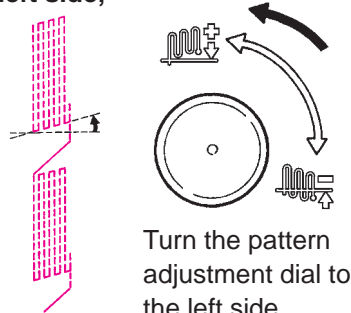

When right side is lower than left side,

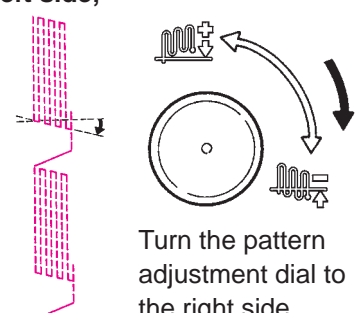

Operational buttons and screen

Needle-stop position

	Stop with needle up
	Stop with needle down

Stitch Pattern No.

Presser foot to be used (symbol)

Zigzag width

Zigzag width adjusting dial

* Adjusting buttons on F400/F300.

Clear button

Selection button

Pattern selection button

Pattern select mode

	Direct select
	Select by number
	Cell phone input

Sewing pattern

Number of patterns selected

Length of stitch

Elongation (Refer to page 89)

Stitch length adjusting dial

* Adjusting buttons on F400/F300.

Confirmation button

One-point/letter selection button

Needle stop position switching button

Continuous stitch button

Mirror image button

Option button

Save/call button

Note: The Cell phone input mentioned here is the input method that is used in cell phones. For example, in input mode, when you press three times and the letter 'C' will be selected.

■ How to select pattern (letters)

Example:



Press



Press **OK**

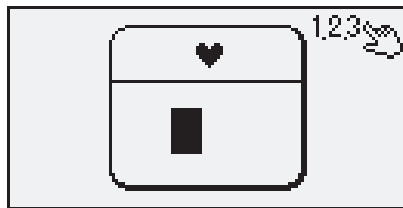

Press **1** **@/!**
and **6** **MNO**.

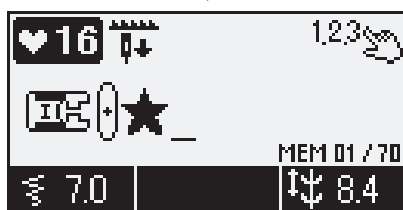

(Pattern No. 16)

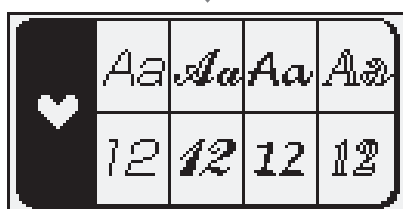

Press **ABC**



Press **>**
Select **Aa**

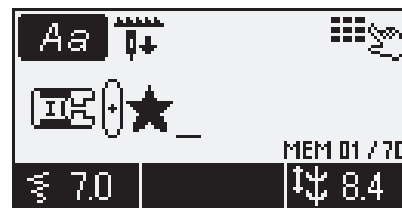

Press **OK**

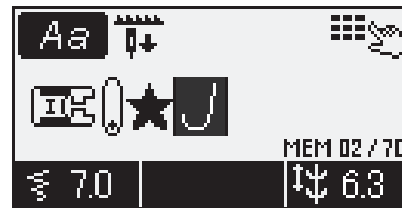

Press **5** **JKL**
one time.

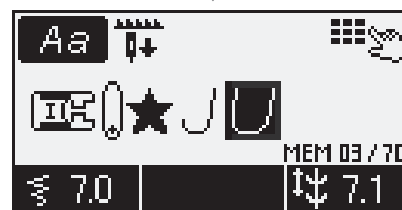

Press **8** **TUV** twice.

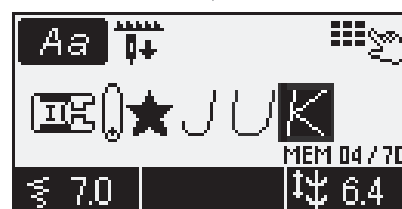

Press **5** **JKL** twice.



Press **4** **GHI**
three times.

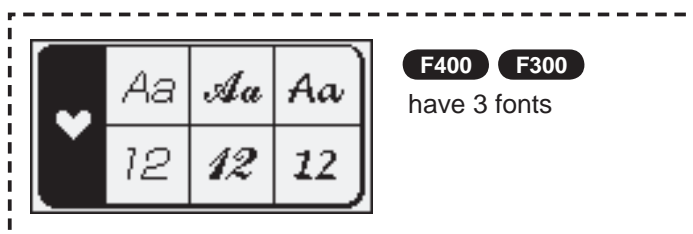

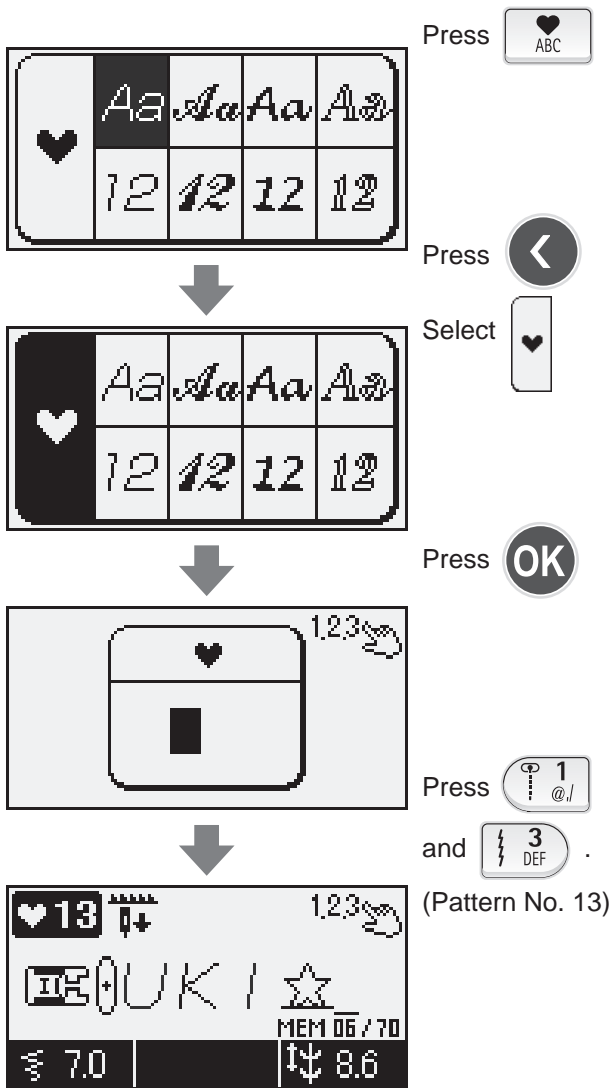

When you want to change the size of pattern (letters)

Move the cursor to the desired pattern (letter). You can change the height and width by:

Height: Zigzag width adjusting dial
Width: Stitch length adjusting dial

■ How to edit patterns (letters)

Example)

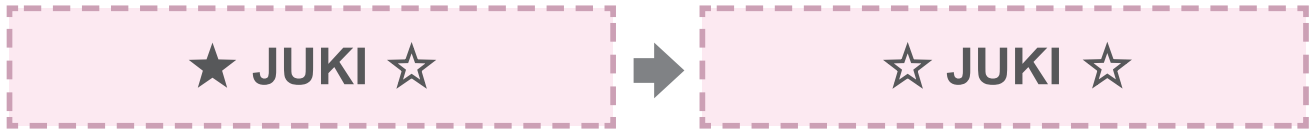

Change ★ to ☆.



Press , and move the '␣'(cursor) to the position where you wish to delete.

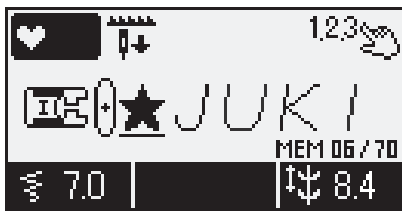

By pressing , the pattern on the cursor "★" will be deleted.



Press .

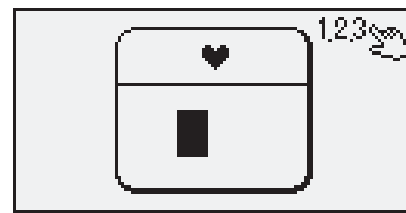

Press .

Press .

and .

(Pattern No. 13)

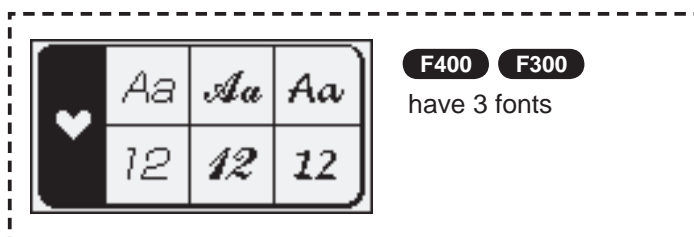
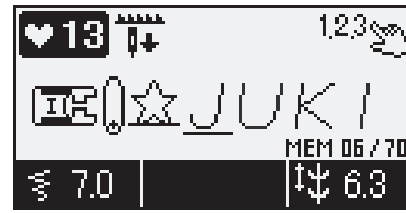

■ How to stitch a pattern (letters)

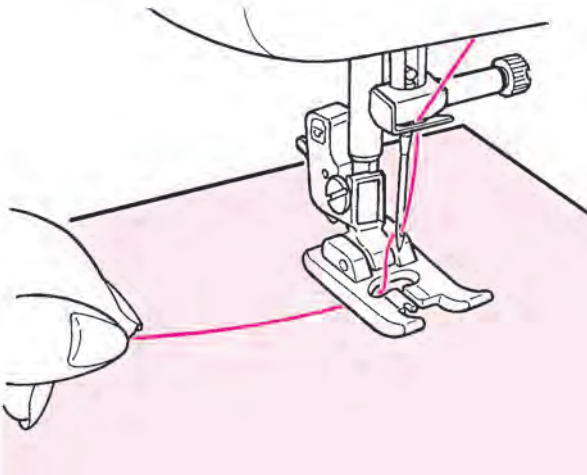

Place the fabric underneath the presser foot and start.

The machine will stop automatically when sewing is finished.

Notes:

1. Note that the sewing speed varies according to stitch patterns (letters) to be sewn.
2. If the automatic thread trimmer is used while sewing, the machine starts to sew from the beginning.
3. In case of condensed sewing, if the stitch length is too small, the stitches may get stuck.

■ Disposing thread ends of jump stitches



Get rid of unnecessary thread on the front side of fabric by scissors.

■ Save/call of patterns (letters)

The letters and one point patterns can be combined and saved for later use.
There are 10 folders in total for saving.

(Save)



Press

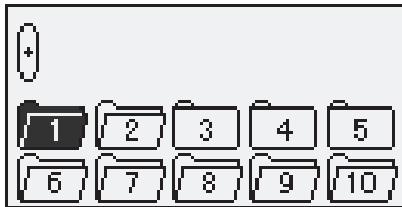

Use to select folder to save and press

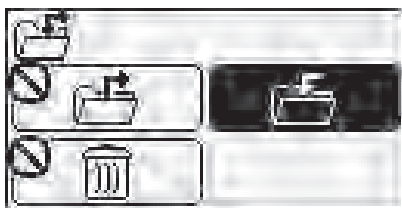

Notes: means there exists already a pattern.
 means empty and available for saving pattern.

Press



(Call)

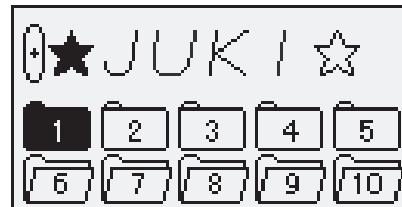

Press

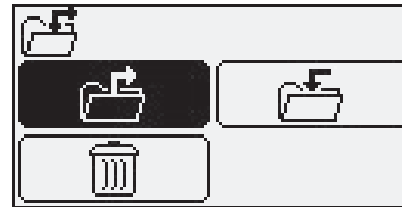

Press to select the folder where you wish to call the desired combination.

Press

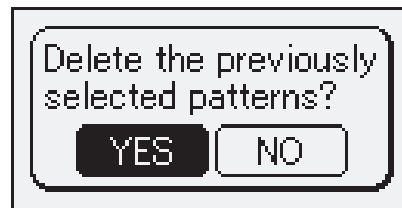

Press

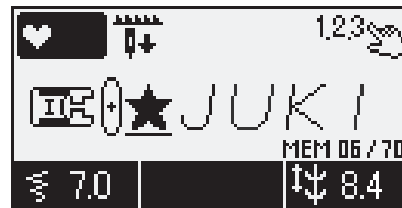

Press

★ To delete the content stored inside a folder.

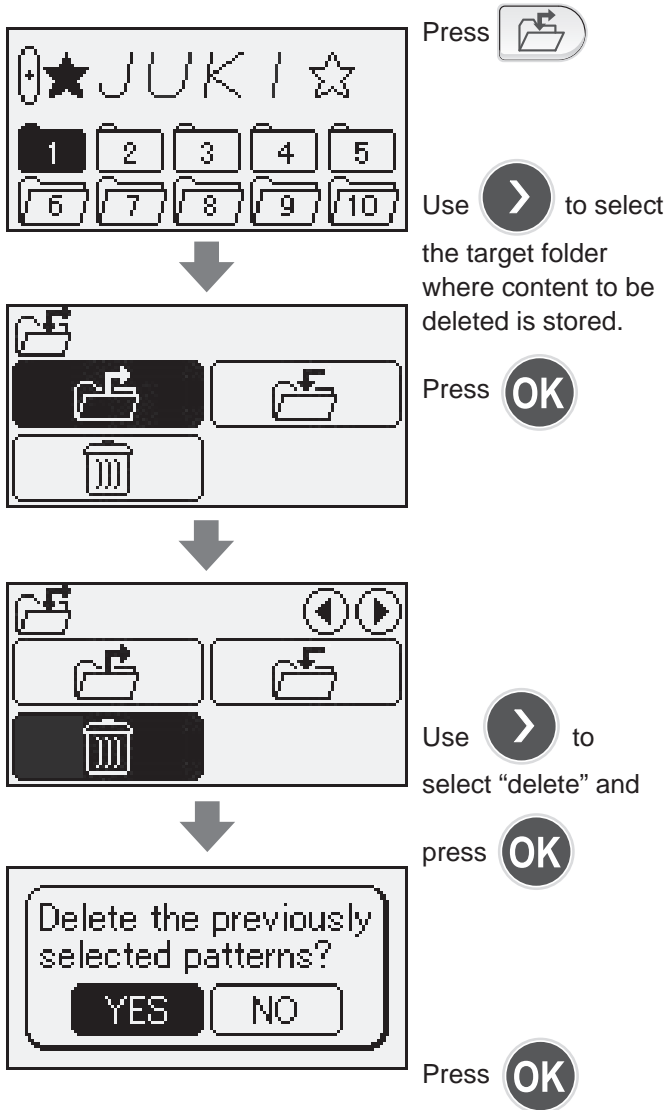

Character selecting methods

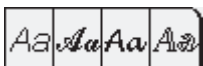

	No. of pressing a button													
	1	2	3	4	5	6	7	8	9	10	11	12	13	14
	@	!	&	'	()	,	.	?	-	.	/	:	;
	A	B	C	a	b	c								
	D	E	F	d	e	f								
	G	H	I	g	h	i								
	J	K	L	j	k	l								
	M	N	O	m	n	o								
	P	Q	R	S	p	q	r	s						
	T	U	V	t	u	v								
	W	X	Y	Z	w	x	y	z						
	-													

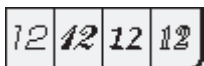

	No. of pressing a button
	1
	1
	2
	3
	4
	5
	6
	7
	8
	9
	0

		No. of pressing a button				
		1	2	3	4	5
	Immediately after selecting A	Ä	Å	Æ	A	
	Immediately after selecting a	à	ä	å	a	
	Immediately after selecting C	Ç	C			
	Immediately after selecting c	ç	c			
	Immediately after selecting e	è	é	ê	ë	e
	Immediately after selecting i	ì	i			
	Immediately after selecting N	Ñ	N			
	Immediately after selecting n	ñ	n			
	Immediately after selecting O	Ö	ø	O		
	Immediately after selecting o	ò	ö	ø	œ	o
	Immediately after selecting U	Ü	U			
	Immediately after selecting u	ù	ü	u		
Other than the above letters	Ineffective					



Type and usage of options

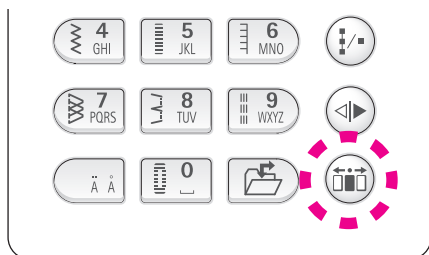

< Type of options >

	Changing the seam width of buttonhole
	Change of needle position
	Setting thread trimming foot switch
	Twin needle sewing
	Guide
	Contrast of Liquid Crystal Display (LCD)
	Button reception buzzer volume setting
	Language setting
	Elongation

① Change of seam width of buttonhole

The seam width of buttonhole is changeable.
* It is changeable when sewing a buttonhole.



Small Standard Large

* Default setting is "standard".

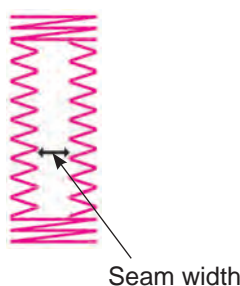

Example) narrowing (reducing) the seam width

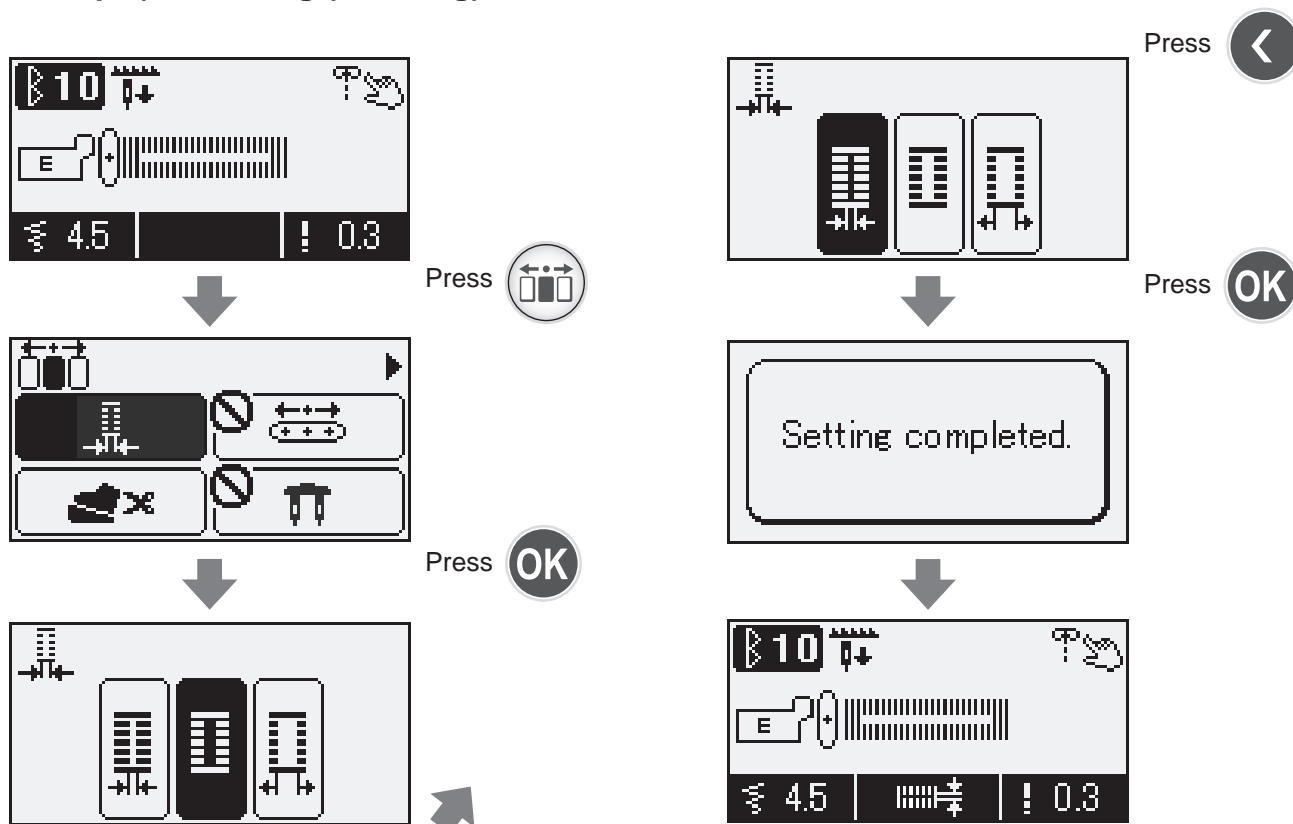

The width is now changed.

* When opening buttonhole with a ripper, make sure not to cut the stitches.

* The setting goes back to the default setting after the sewing machine is turned off and on.

② Change of needle position

Example) change the needle position of zigzag stitch to left needle position.

* Default setting is center needle position.

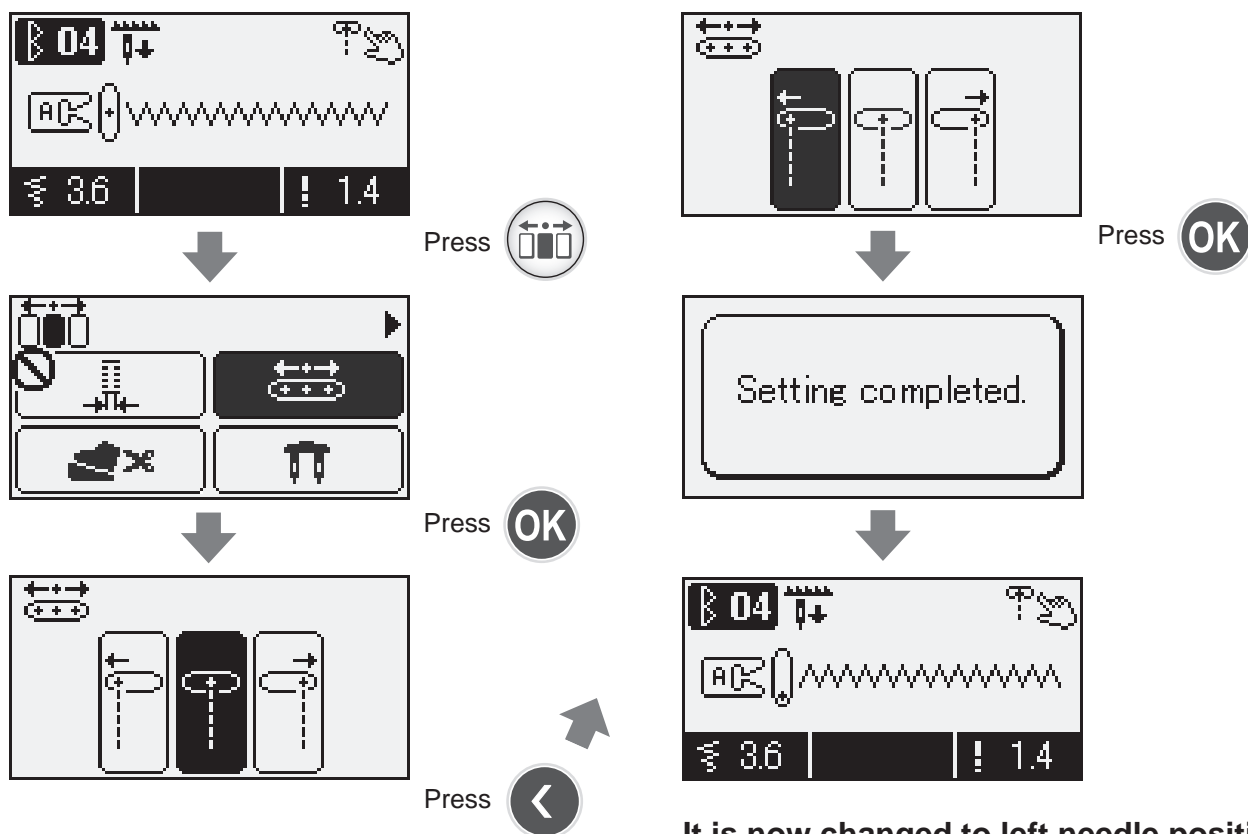

It is now changed to left needle position.

* In case of a combined stitch pattern, if the needle position is changed, the needle position of the selected patterns is all changed to the same needle position at the same time. However, if letter is included in the combined stitch pattern, needle position will not be changed.

* After a change of needle position and in the event that other stitch pattern is selected, the sewing machine goes back to the default setting.

③ Setting the thread trimming foot switch to OFF

In order to avoid trimming the thread by mistake while sewing, you can set the thread trimming foot switch to "off" beforehand.

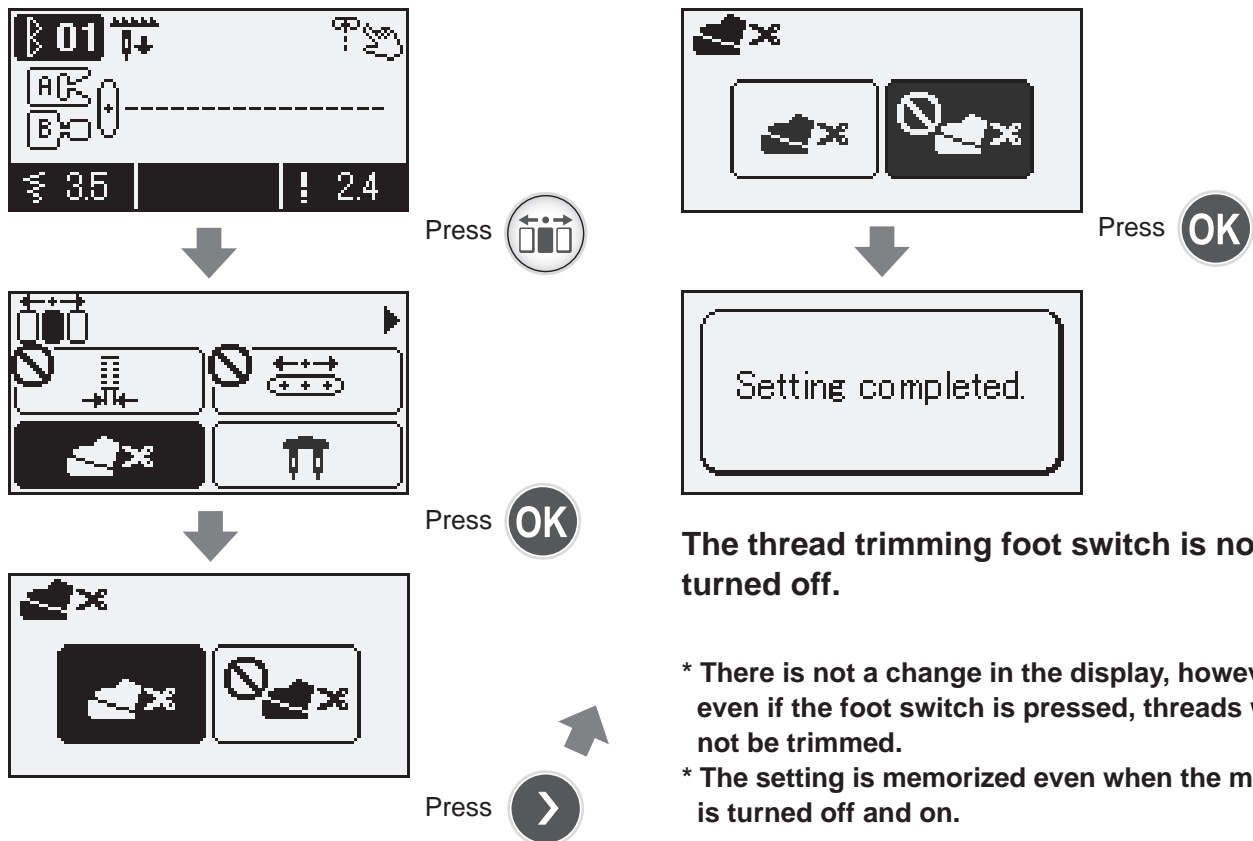

④ Twin needle sewing

By using two needles beautiful decorative stitches can be sewn.

* When using twin needles, make sure to set twin needle sewing in Option  and perform test sewing.

* When twin needle sewing, make sure to use thread size smaller than No. 60.

* Make sure to use a twin needle with size of 2.0 mm (included needle: 2.0 mm).

* When twin needle sewing, the sewing speed will become slower.



Attention

Turn OFF the power switch before replacing the presser foot.

Pattern No.	Direct 1, 4
	F600 One-point 17, 19, 20, 21, 24~31, 34~38
	F400 One-point 17, 19, 20, 21, 24~29, 31~33
	F300 One-point 9, 10, 13~17
Presser foot	Standard presser foot (A) Manual buttonhole presser foot (I)

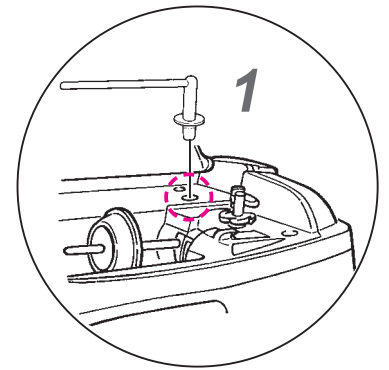
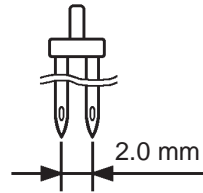

* Bobbin winding is also possible with supplementary spool pin.

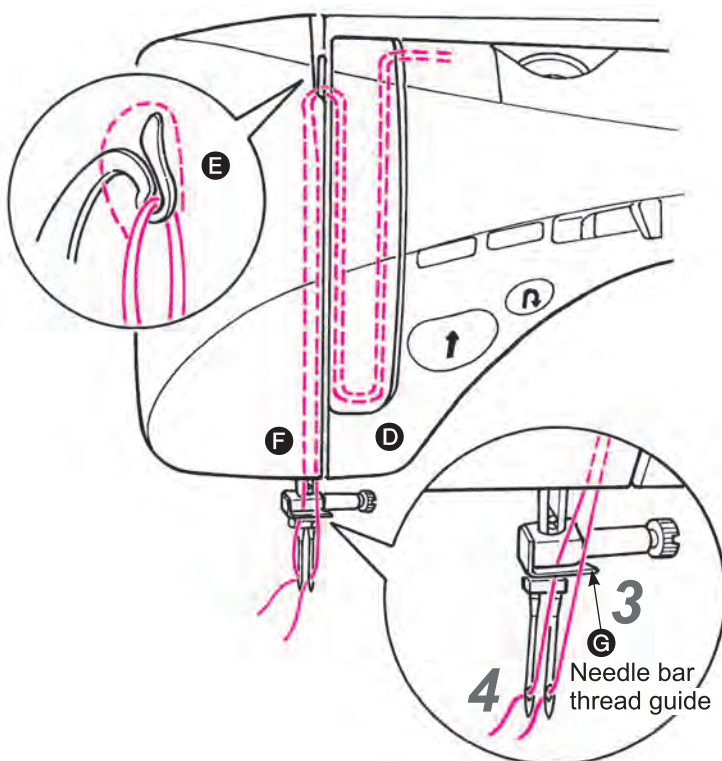
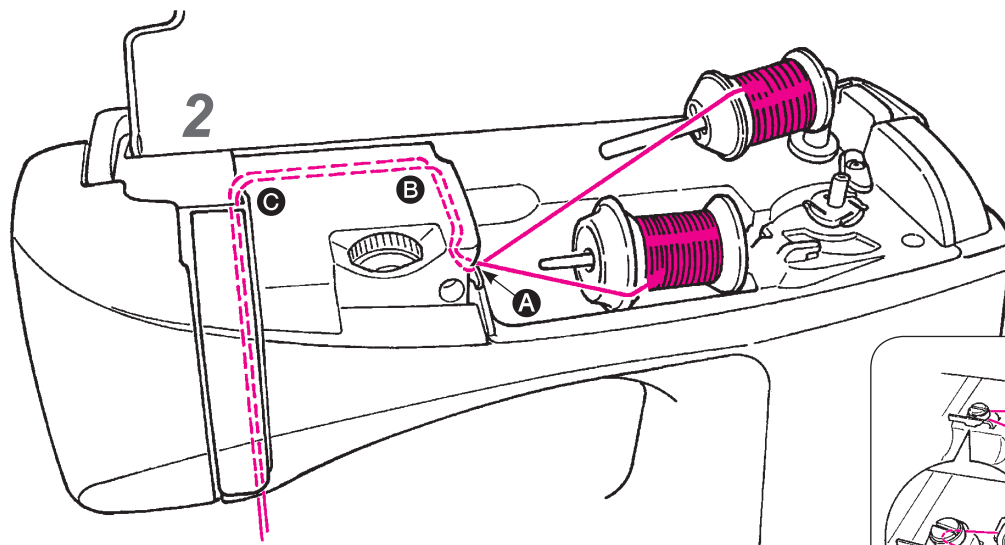
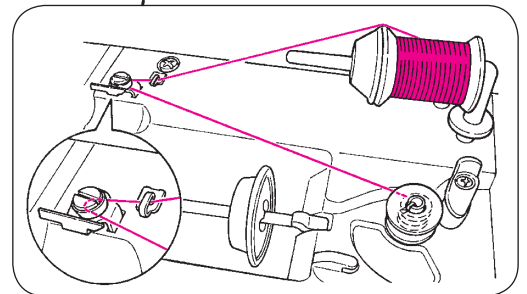

■ How to thread the needles

- 1 Place the supplementary spool pin.
- 2 Thread to the thread guide **A** first. After that, thread paths are same up from **B** to **F**.
- 3 Do not thread **G** for right-hand needle.
- 4 Thread to right-hand and left-hand needles separately.

* Automatic needle threader can not be used. Thread each needle manually.

* Automatic thread trimmer can not be used in case of twin needle sewing.

■ Setting of twin needle sewing

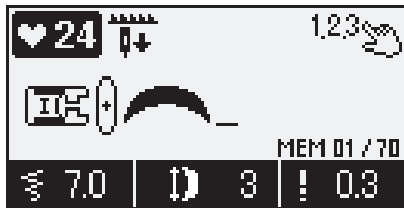

* Select a stitch pattern suitable for twin needle sewing.

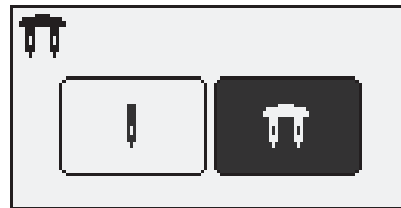

Press **OK**

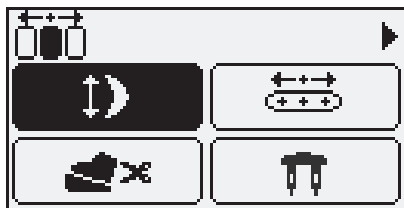

Press

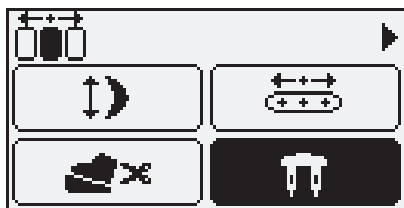
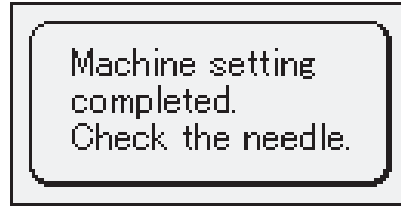

Press three times.

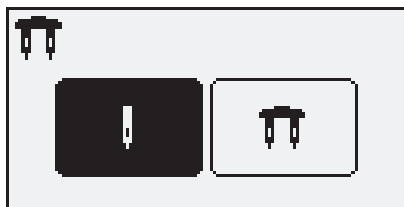
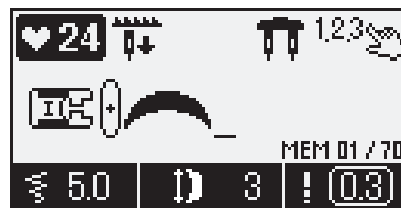

Press **OK**

Press

Symbol of twin needle sewing will be shown on the display.

- * When in twin needle sewing, the stitch patterns will be limited. In addition, the stitch length and zigzag width will be also adjusted to suit the twin needle sewing.
- * The setting is memorized even when the machine is turned off and on.

* Twin needle setting can not be done while a stitch pattern other than those for twin needle sewing is selected.



mark will be shown.



The twin needle setting can only be carried out when suitable pattern is selected and center needle position is selected at the same time.

* Maximum zigzag width is 7.0 mm, however, display shows .

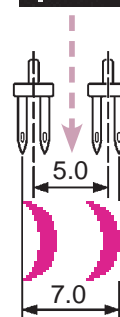

The sewing image



Maximum 7.0 mm

⑤ Guide

The guide for winding bobbin thread, setting of bobbin, threading of needle thread, changing presser foot and needle can be seen on the LCD display.

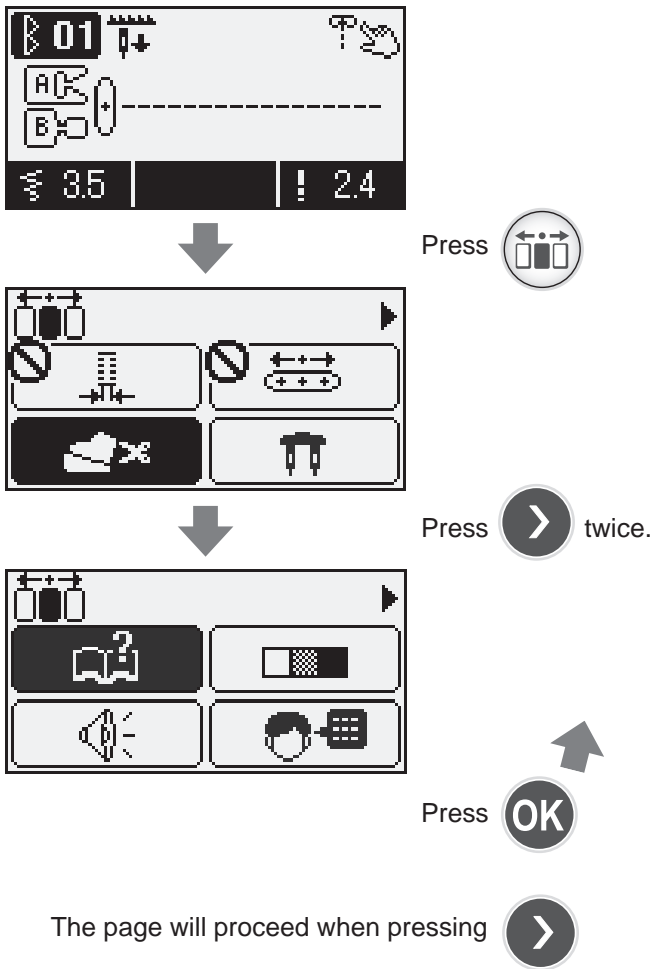

<Winding bobbin thread>

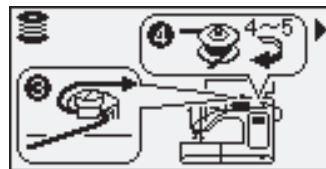
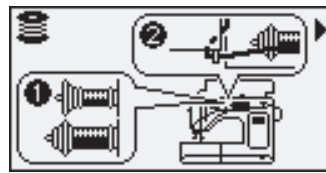

<Setting of bobbin>

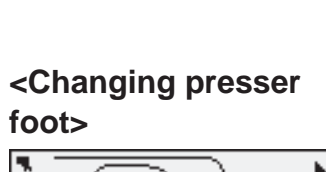

<Threading of needle thread>

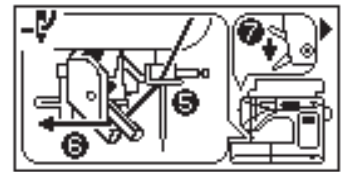
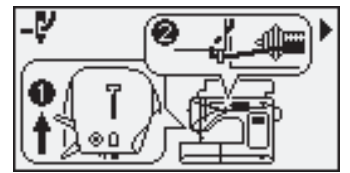

<Changing presser foot>

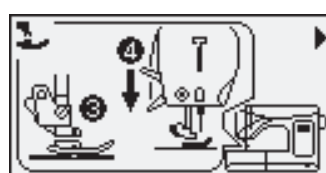
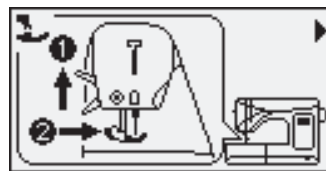

<changing needle>

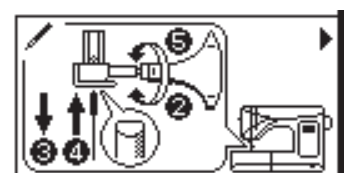
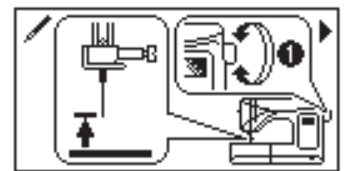

Press or to end the guide.

⑥ Contrast of Liquid Crystal Display (LCD)

The LCD contrast can be chosen from 11 levels.

Example) Reduce the contrast of display.

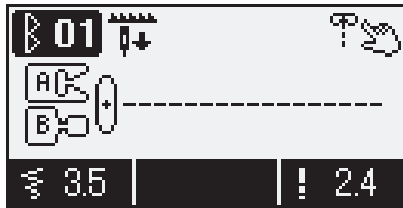

Press 

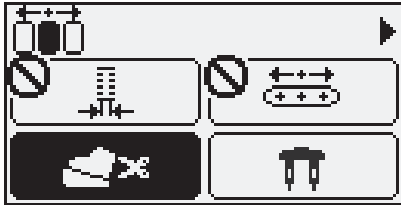

Press  three times.

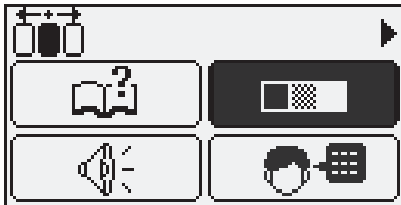

Press 

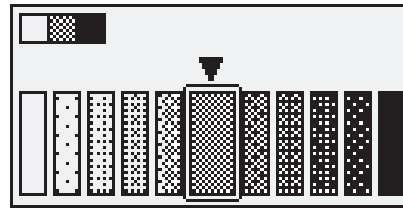

Press 

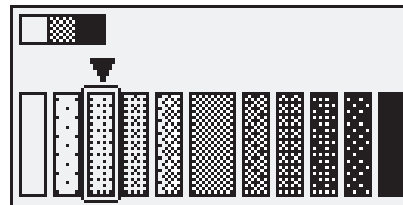

Press 



The contrast is now changed.

* The setting is memorized even when the machine is turned off and on.

⑦ Button reception buzzer volume settings

The volume of buzzer can be adjusted.

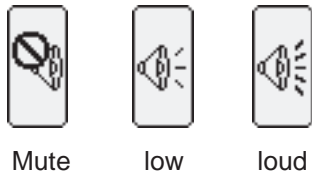

Example) Setting the volume to “mute”

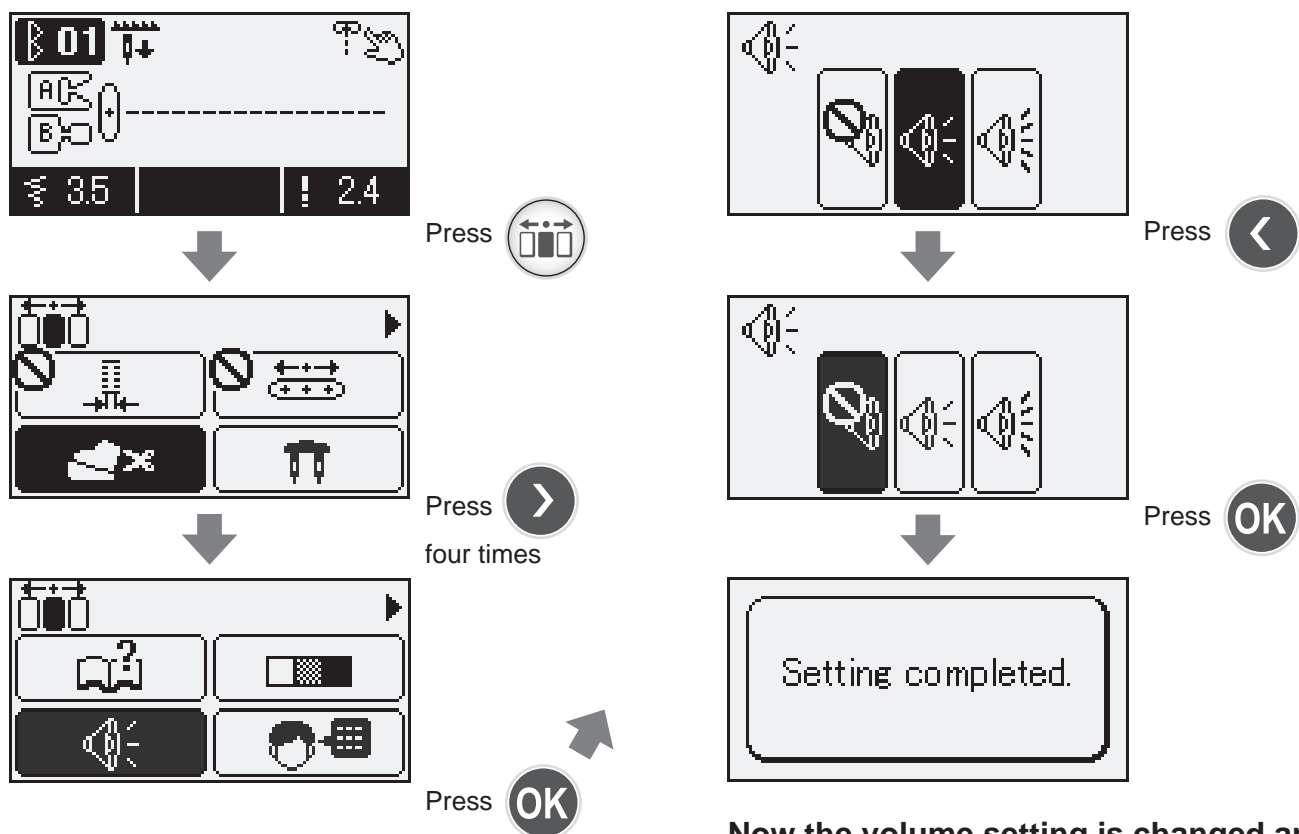

Now the volume setting is changed and it will not produce a sound even when a button is pressed.

* The setting is memorized even when the machine is turned off and on.

⑧ Language setting

You can select language from 8 languages or pictographs.
(Default setting is English.)



Example) Change the language to Italian.

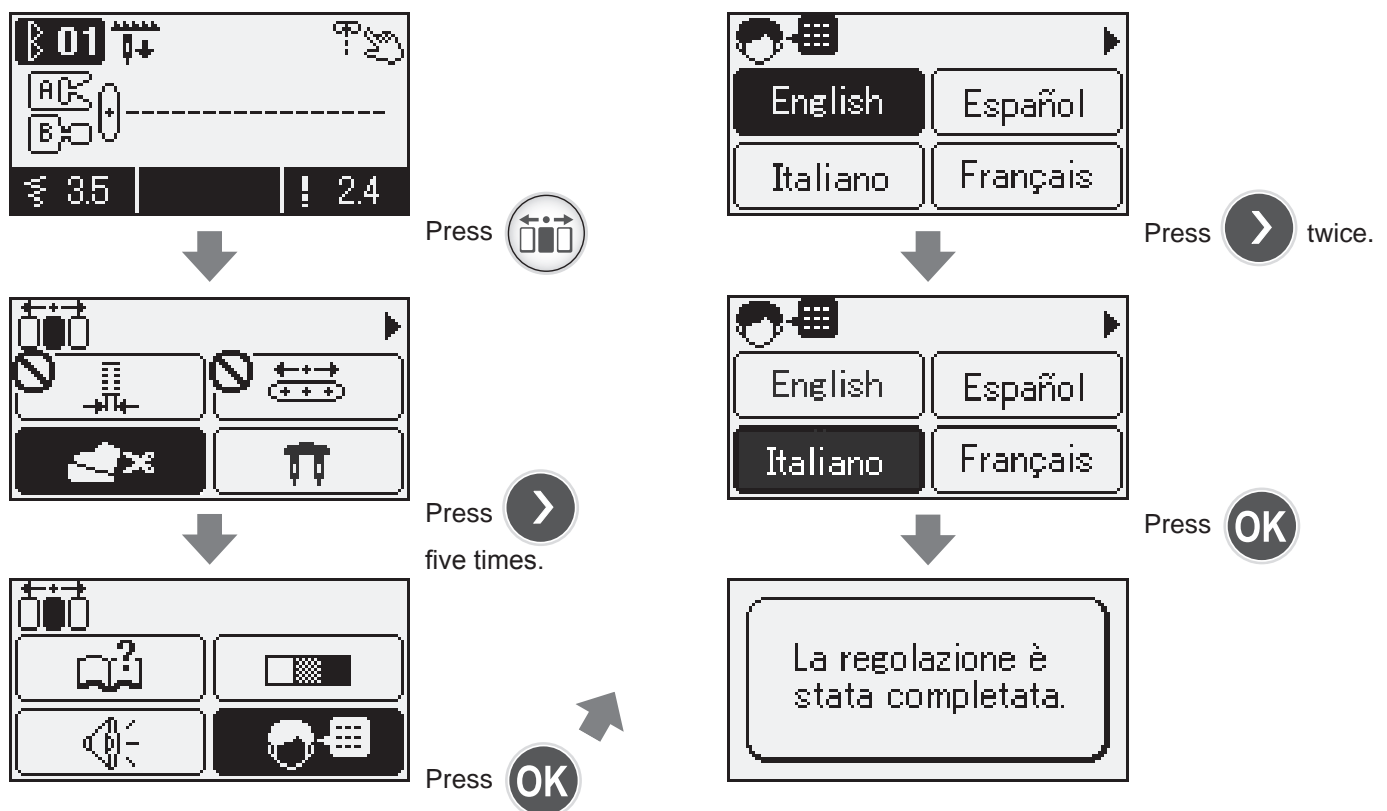

The language is now changed to Italian and all messages will be displayed in Italian from now on.

* The setting is memorized even when the machine is turned off and on.

⑨ Elongation

Pattern No.	F600 One-point 24~38
	F400 One-point 24~33
	F300 One-point 13~18

The length of the patterns (stitch pattern **F600** No.24 ~ 38, **F400** No.24 ~ 33, **F300** No.13 ~ 18) can be adjusted.

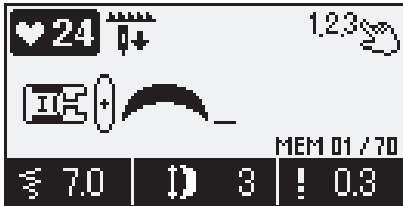





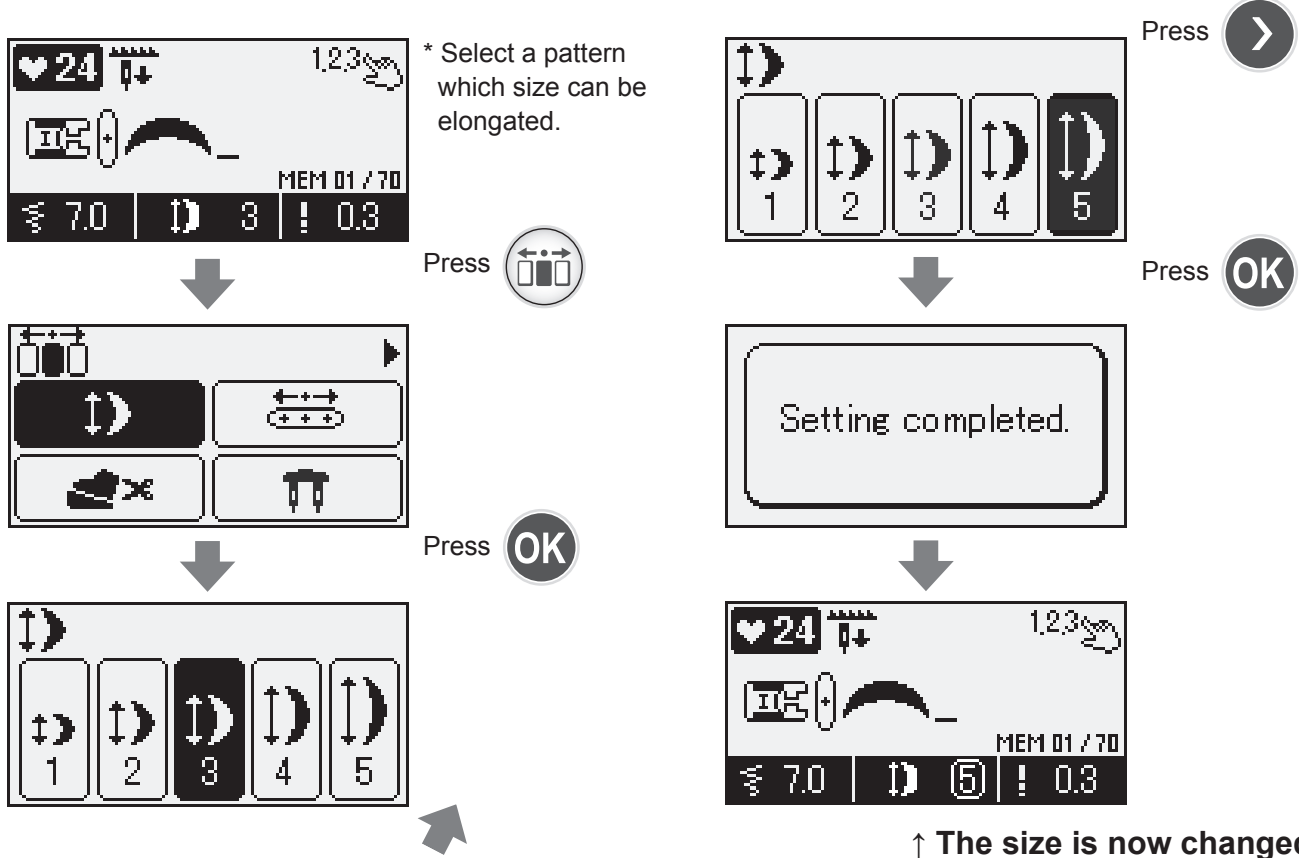





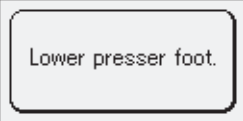
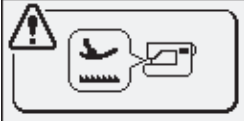
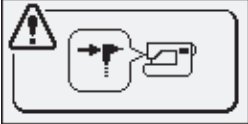
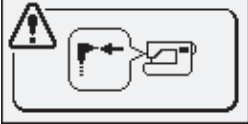
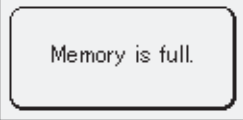

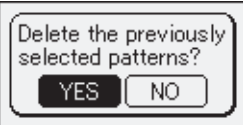

↑ Adjusting range is from size 1 to size 5. (Default setting is size 3.)

Example) changing to size 5

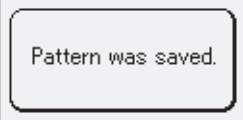

* The setting is memorized even when the machine is turned off and on.

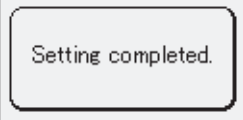
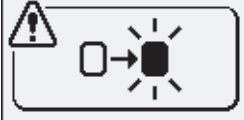
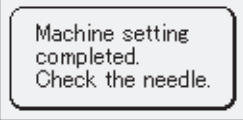
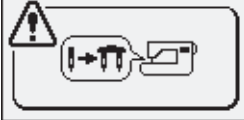
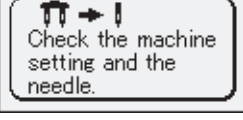
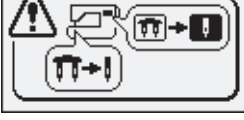
Message catalog

	Message	Cause (Reason to display such messages)
1	 	<p>A. When “start/stop”, “reverse stitch” or “thread-trimming” button is pressed while the presser foot is raised.</p> <p>B. When presser foot is raised while sewing.</p>
2		<p>A. When one of the buttonhole stitches is selected and the buttonhole sensor pin is not connected, the machine starts to sew.</p>
3		<p>A. When a stitch pattern other than buttonholes is selected but the buttonhole sensor pin is connected, the machine starts to sew.</p>
4	 	<p>A. When in the  mode, user attempts to select stitch patterns more than the maximum number of memory (70).</p>
5	 	<p>A. When in the  mode and more than one stitch pattern is selected, user attempts to move to mode  and/or .</p> <p>B. When in the  mode and more than one stitch pattern is selected, user presses the  button for more than two seconds (deleting all).</p> <p>C. When in the  mode and more than one stitch pattern is selected, user presses the  button (calling a memory).</p>
6	 	<p>A. When the process of saving a pattern into folder is completed.</p>
7	 	<p>A. When in the option setting, settings which will be kept after turning off the machines are changed. (Thread trimming by foot controller, LCD contrast, buzzer volume and language setting)</p>
8	 	<p>A. When the setting of the machine is changed to twin needle sewing (option setting).</p>
9	 	<p>A. When in twin needle sewing, a stitch pattern other than twin needle sewing is selected.</p>
10		<p>A. When the motor is locked, the machine stops temporarily for safety.</p>

Introduction of optional accessory parts

Make your home sewing more pleasant!

Please purchase the following items in the shop where you buy our products.

● Rolled hemming presser foot

Fabric edge is hemmed while rolling it under. Used for bottom of shirts, blouses, frills and the edge of handkerchiefs.

F600 F400 F300

● Button attaching presser foot

This presser foot is used to attach buttons on garments.

F600 F400 F300

● Quilt presser foot (transparent type)

It is used for free-motion quilting. Zigzag stitch is also possible with this presser foot.

F600 F400 F300

● Cording and Embroidery presser foot

It is used in free motion quilting and a cord can be sewn together with this presser foot.

F600 F400 F300

● Pearl attaching presser foot

With this presser foot it is possible to attach pearls, beads and thick cord.

F600 F400 F300

● Presser foot with guide

As the presser foot has markings, which show 2 mm distance, these marking will serve as a guide.

F600 F400 F300

● Throat plate for straight stitch

Use with patchwork presser foot for better stitch quality.

F600 F400 F300

● Binder presser foot

It is possible to attach tapes such as bias tape into four folds.

F600 F400 F300

● Hemming presser foot for zigzag

Fabric edge is hemmed by zigzag while rolling it under. Used for bottom of shirts, blouses, frills and the edge of handkerchiefs.

F600 F400 F300

● Quilt presser foot (open type)

It is used in free motion sewing. As the front portion is open, it is easy to see the needle entry point.

F600 F400 F300

● Appliqué presser foot

Since the front and back of the presser foot is short, it is easy to move the materials at curve points. Also fabrics can be seen easily because it is transparent.

F600 F400 F300

● Cording presser foot (for 3 cords)

It is possible to attach 1 - 3 cords by three-point zigzag or decorative stitch.

F600 F400 F300

● Invisible zipper foot

As a seam does not appear on the right side of the fabric, an opening can be finished with fabric edges neatly butted.

F600 F400 F300

- **Smooth presser foot**

This presser foot is used for non-slippery materials like vinyl and satin stitches.

F400 F300

- **Eyelet punch**

This is to open hole at round area of keyhole buttonhole.

F400 F300

- **Wide Table**

For sewing large projects such as quilts, etc.

F400 F300

- **Open toe presser foot**

This presser foot is used for appliqué and decorative stitches. (Front part of the presser foot is open for better visibility.)

F400 F300

- **Edge sewing presser foot**

This presser foot is used for patchwork, sewing center line of joined materials by using the center guide of the presser foot.

F400 F300

- **Walking foot**

This presser foot is used for "difficult-to-feed" materials such knit, jersies, vinyl, artificial leather and leather or quilting.

F300

- **Auxiliary spool pin**

This spool pin is used for twin needle sewing or for bobbin thread winding.

F300

- **Quilt presser foot**

This presser foot is used for quilt stitches (free motion quilting).

F300

- **Patchwork presser foot**

This presser foot is used for patchwork stitches.

F300

- **Quilt guide**

This is a guide is to sew lines in the same distance.

F300

- **Knee lifting lever**

You can raise or lower presser foot by knee, without using your hand.

F300

How to install Wide Table

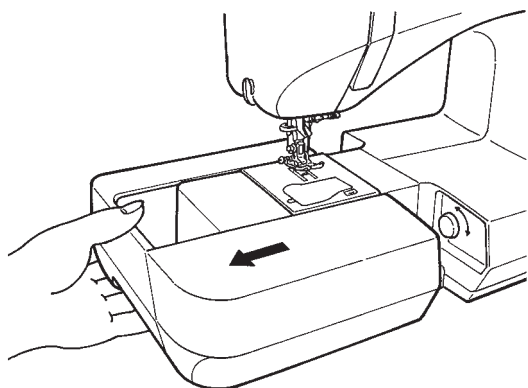

1 Remove auxiliary bed.

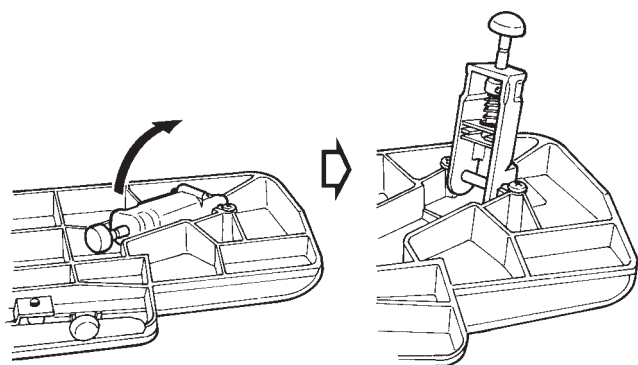

2 Open legs of Wide Table until they stop securely at the stopping position.

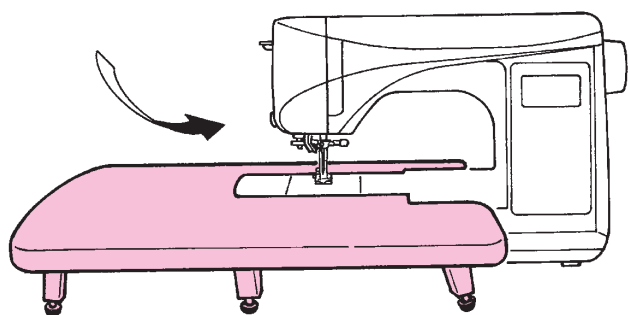

3 Assemble Wide Table to sewing machine body.

Attach it to free arm of sewing machine.

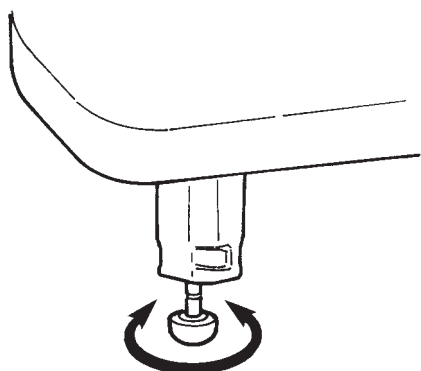

4 Adjust the height of legs so that the top surface of Wide Table is the same height of sewing machine body.



Attention

- * Don't put any heavy materials on the Wide Table.
- * Don't move sewing machine with Wide Table attached.

Machine Maintenance

When lint and/or dirt has built up, it may cause machine failures. Therefore, clean the machine frequently.

Attention

Always must be disconnected plug from socket-outlet before remove throat-plate and remove bobbin-case-holder.

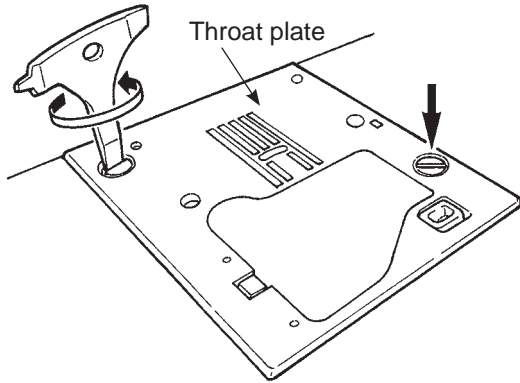

1 Remove the throat plate

Remove needle and presser foot and remove the needle plate by using T-shape screwdriver.

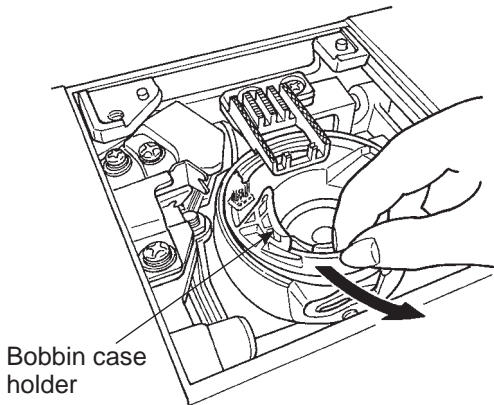

2 Remove the bobbin case holder.

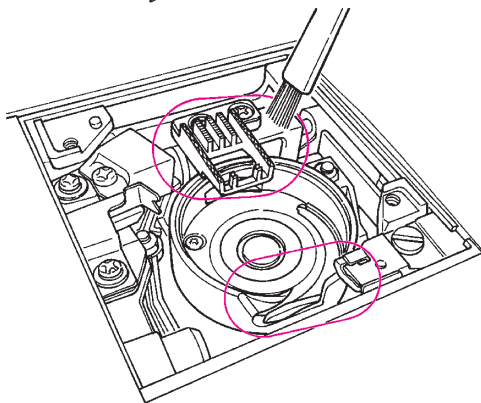

3 Remove lint and dirt.

Remove lint and dirt around the feed dog and bobbin case holder with the cleaning brush.

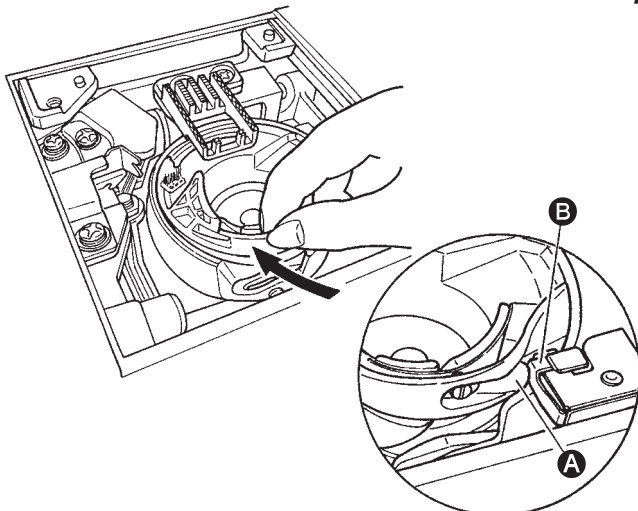

4 Install the bobbin case holder.

Install the bobbin case holder so that points **A** and **B** touch each other.

Install the throat plate.

When attaching the throat plate, align the positioning pins with holes of throat plate.

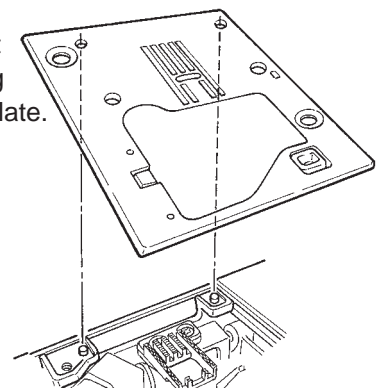

Performance check list

If sewing difficulties occur, make sure the instructions are correctly followed.

If a problem still exists, the reminders below may help solve it.

Case	Cause (Reason)	Solution	Reference page
<ul style="list-style-type: none"> The machine stops sewing suddenly. (This is in case you can turn hand wheel by hand.) 	<ul style="list-style-type: none"> The machine sews at slow speed continuously. (The machine has a mechanism to automatically cut off the power to prevent the motor from overheating.) 	<ul style="list-style-type: none"> Turn off the power and wait for a while (about 10 minutes). The safety mechanism will be reset and the machine will return to normal. 	2
<ul style="list-style-type: none"> The machine will not work even when started. 	<ul style="list-style-type: none"> Presser foot is in up position. 	<ul style="list-style-type: none"> Lower the presser foot and start to sew. 	12
<ul style="list-style-type: none"> The machine will not work even when start/stop button is pressed. (This is in case sewing light is still on.) 	<ul style="list-style-type: none"> The needle hits presser foot due to an installation of incorrect presser foot. The needle fell into the hook area and tried to start. 	<ul style="list-style-type: none"> Use the appropriate presser foot to the selected stitch pattern. Remove the needle from the hook area. 	- -
<ul style="list-style-type: none"> Needle breaks. 	<ul style="list-style-type: none"> Thick material is sewn with a thin needle. The needle is not inserted fully. The needle setscrew is not securely tightened. The wrong presser foot is used for a certain pattern. 	<ul style="list-style-type: none"> Check the combination of fabric, thread and needle. Check the installation of needle. Securely tighten the needle setscrew. Check the combination of stitch pattern and presser foot to be used. 	24 23 23 -
<ul style="list-style-type: none"> Loud noise and/or keen noise while sewing 	<ul style="list-style-type: none"> Lint or dust has accumulated in the feed dog. Lint or dust has accumulated in the hook. 	<ul style="list-style-type: none"> Clean the feed dog area. Clean the hook area. 	94 94
<ul style="list-style-type: none"> Machine fails to feed fabrics. 	<ul style="list-style-type: none"> The stitch length is set at "0". Soft fabrics such as towels are being sewn. The machine is set in drop feed condition. (the drop feed knob is on the right side) 	<ul style="list-style-type: none"> When the stitch pattern is reselected, the machine goes back to the default setting. Set the stitch length to 3 – 5. Set the drop feed knob to left side. 	36 - 26
<ul style="list-style-type: none"> Needle can not be threaded. (This is in case needle threader will not turn.) The hook of needle threader does not go through the needle eye. 	<ul style="list-style-type: none"> The needle is not in the up position. (When needle is not in the up position, needle threader will not turn. This is to avoid damages to the hook.) The needle is not inserted fully. 	<ul style="list-style-type: none"> Rotate the hand wheel and lift the needle upwards. Check the installation of the needle. 	21 23

Case	Cause (Reason)	Solution	Reference page
<ul style="list-style-type: none"> The needle threading lever will not return to the original position and the machine can not turn properly. (This is in case the hook of needle threader remains in the needles eye.) 	<ul style="list-style-type: none"> Hand wheel is turned by mistake while the needle threading lever is in down position. (in the process of threading to the needle.) 	<ul style="list-style-type: none"> Turn hand wheel slightly away from you. (to the opposite side when sewing). 	-
<ul style="list-style-type: none"> The machine will not start even when start/stop button is pressed. 	<ul style="list-style-type: none"> The foot controller is plugged in. 	<ul style="list-style-type: none"> Start/stop button can function when foot controller is removed. 	8
<ul style="list-style-type: none"> Thread breaks. Stitch is skipped. 	<ul style="list-style-type: none"> The machine is incorrectly threaded. There is knot or knurl on the thread. The setting of manual thread tension is incorrect. The needle is bent or the tip of needle is broken. The needle is installed incorrectly. Threading of bobbin thread is not correct. The bobbin can not turn smoothly inside the hook holder. The needle size does not match the thread. Thread take-up is not threaded. 	<ul style="list-style-type: none"> Rethread the machine correctly. Remove knot or knurl from thread. Adjust thread tension manually according to fabrics and thread to be used. Change needle. Install needle correctly. Check the correct way of setting bobbin thread. Check the correct way of winding bobbin thread. Check the combination of thread and needle. Rethread the machine correctly. 	19 - 25 23 23 17 - 24 19
<ul style="list-style-type: none"> Thread tension is not good. 	<ul style="list-style-type: none"> The needle thread is threaded in correctly. The bobbin thread is threaded incorrectly. The direction of spool cap doesn't match the spool. 	<ul style="list-style-type: none"> Rethread the machine correctly. Check the correct way of setting bobbin thread. Attach the spool cap in a correct direction. 	19 17 19
<ul style="list-style-type: none"> Puckering occurs. 	<ul style="list-style-type: none"> The stitch length is too large on light-weight fabrics. The needle tip is broken. 	<ul style="list-style-type: none"> Make the stitch length smaller (shorter). Change needle. 	36 23
<ul style="list-style-type: none">  sign is shown on the LCD display. 	<ul style="list-style-type: none"> Safety mechanism works when machine stops due to motor lock. 	<ul style="list-style-type: none"> The safety mechanism will be reset in a short while (about 10 minute) and the machine will return to normal. (At this time, the start/stop button will not light up.) 	-

List of stitch patterns

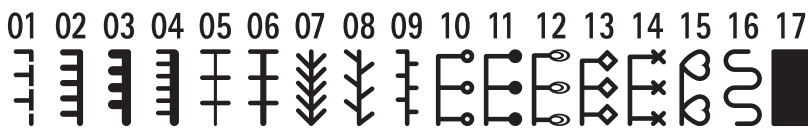
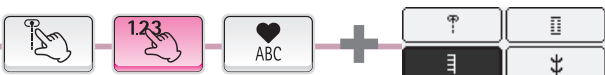
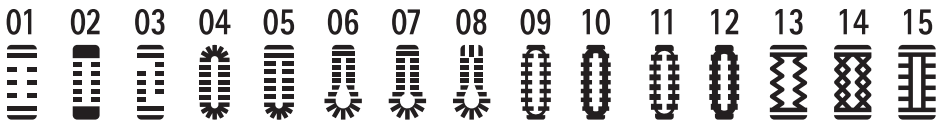
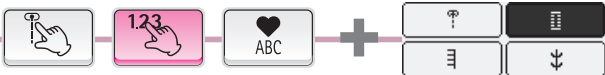
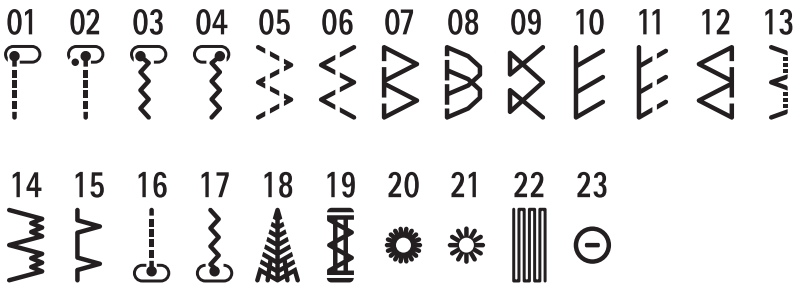
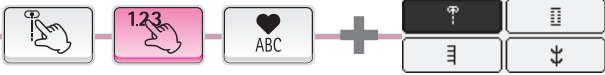
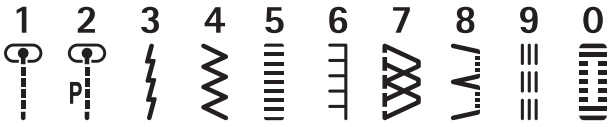

Patterns for crazy quilt

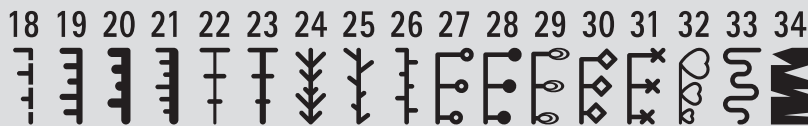

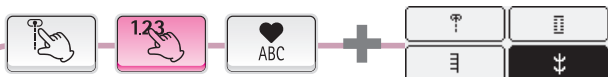

01 02 03 04 05 06 07 08 09 10 11 12 13 14 15 16 17 18 19 20 21 22 23 24 25
 26 27 28 29 30 31 32 33 34 35 36 37 38 39 40 41 42 43 44 45 46 47 48 49 50
 51 52 53 54 55 56 57 58 59 60 61 62 63 64 65 66 67 68 69 70 71 72

One-point



01 02 03 04 05 06 07 08 09 10 11 12 13 14 15 16 17 18 19 20

21 22 23
 ● ☪ ☪
 2.5 2.5

Pattern for elongation

24 25 26 27 28 29 30 31 32 33 34 35 36 37 38

Letters/numbers/signs



@!&' () . , ? - - / : ;
 ABCDEFGHIJKLMNOPQRSTUVWXYZ
 abcdefghijklmnopqrstuvwxyz
 1234567890
 ÄÅÆääääääääëëCœçİñÑŎŐðöøUüü

@!&' () . , ? - - / : ;
 ABCDEFGHIJKLMNOPQRS
 TUVWXYZ
 abcdefghijklmnopqrstuvwxyz
 1234567890
 ÄÅÆääääääääëëCœçİñÑŎŐðöøUüü

@!&' () . , ? - - / : ;
 ABCDEFGHIJKLMNOPQRSTUVWXYZ
 abcdefghijklmnopqrstuvwxyz
 1234567890
 ÄÅÆäåääääääëëCœçİñÑŎŐðöøœUüü

@!&' () . , ? - - / : ;
 ABCDEFGHIJKLMNOPQRS
 TUVWXYZ
 abcdefghijklmnopqrst
 uvwxyz
 1234567890
 ÄÅÆääääääääëëCœçİñÑŎŐðöøœUüü

List of stitch patterns

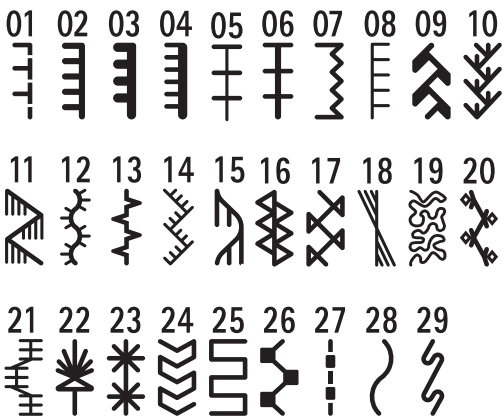
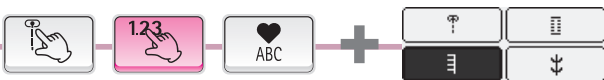
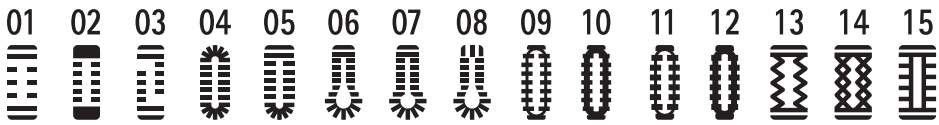
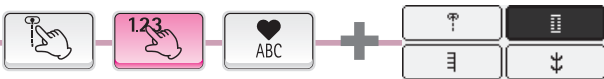
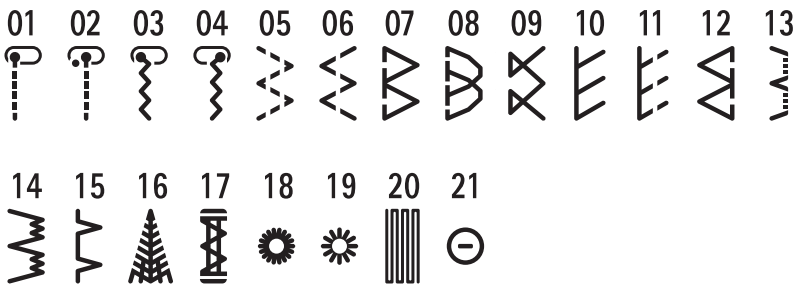
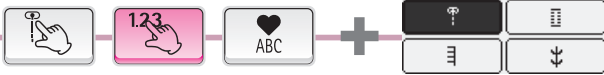
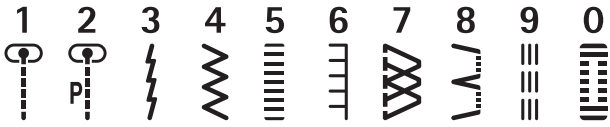

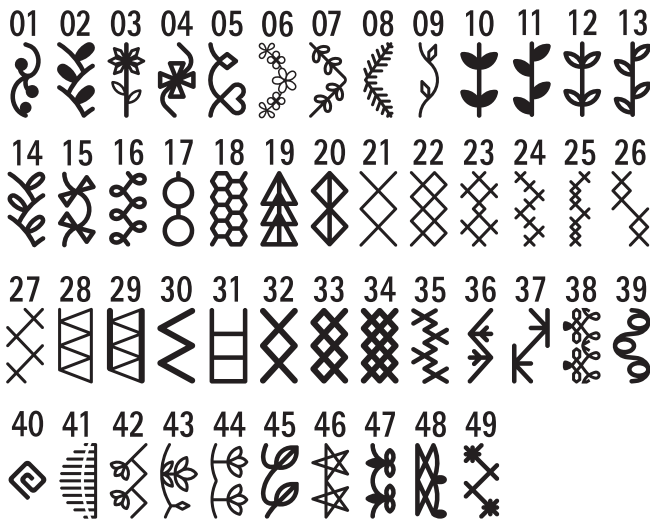
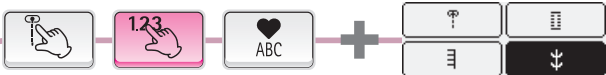

One-point



Pattern for elongation



Letters/numbers/signs



@!&'(),.?-./:;
 ABCDEFGHIJKLMNOPQRSTUVWXYZ
 abcdefghijklmnopqrstuvwxyz
 1234567890
 ÄÅÆääääëëëëÇçİİñÑŒŒŒöŒŒÜüü

@!&'(),.?-./:;
 ABCDEFGHIJKLMNOPQRSTUVWXYZ
 XYZ
 abcdefghijklmnopqrstuvwxyz
 1234567890
 ÄÅÆäväääëëëëÇçİİñÑŒŒŒöŒŒœüüü

@!&'(),.?-./:;
 A B C D E F G H I J K L M N O P Q R S
 T U V W X Y Z
 a b c d e f g h i j k l m n o p q r s t u v w x y z
 1 2 3 4 5 6 7 8 9 0
 Ä Å Æ ä ä ä ä ä ä ä ä ç ç İ İ ñ Ñ Œ Œ Œ ö ö ö œ ü ü ü

List of stitch patterns

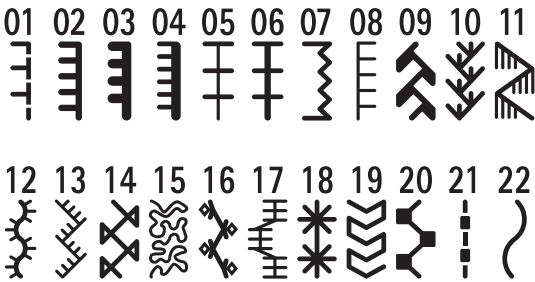
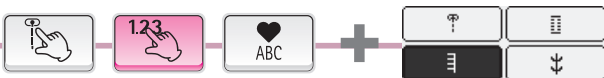
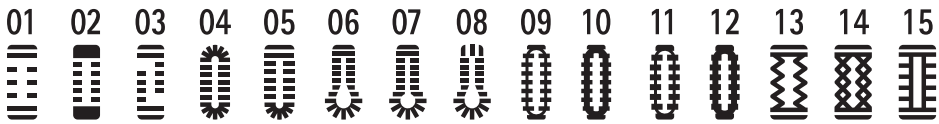
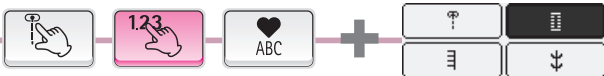
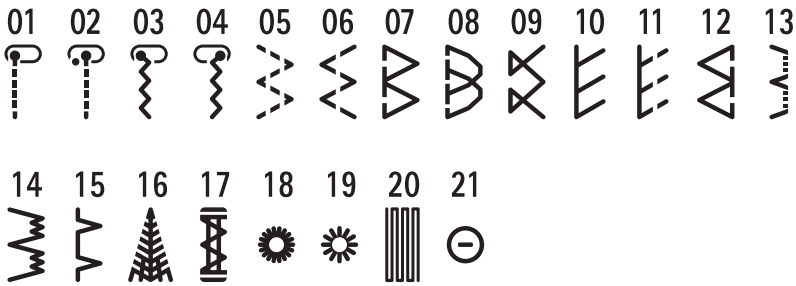
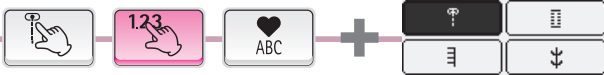
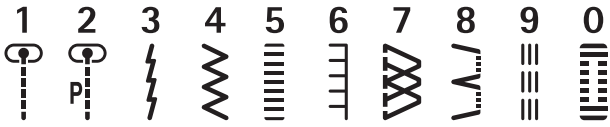

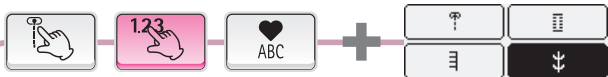

One-point

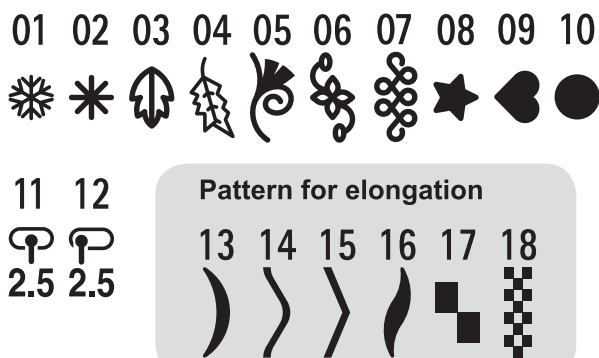

Letters/numbers/signs



@!&' () , . ? - - / : ;
 ABCDEFGHIJKLMNOPQRSTUVWXYZ
 abcdefghijklmnopqrstuvwxyz
 1234567890
 ÄÅÆäääëèéëCœçİñŃŌŒöøÙüü

@!&' () , . ? - - / : ;
 ABCDEFGHIJKLMNOPQRSTUVWXYZ
 XYZ
 abcdefghijklmnopqrstuvwxyz
 1 2 3 4 5 6 7 8 9 0
 ÄÅÆäåäëèéëCœçİñŃŌŒöøœÙüü

@!&' () , . ? - - / : ;
 A B C D E F G H I J K L M N O P Q R S
 T U V W X Y Z
 a b c d e f g h i j k l m n o p q r s t u v w x y z
 1 2 3 4 5 6 7 8 9 0
 Ä Å Æ ä å ä ë è é ë C œ ç İ ñ Ń Ō Œ ö ø œ Ù ü ü

■ Specification list

Item	Specification
Body size	44.5 (W) X 29.1 (H) X 21.0 (D) cm
Body size with hard case	51.0 (W) X 30.5 (H) X 25.7 (D) cm
Weight (Weight with hard case)	9.8 KGS / 21.6 LBS

JUKI®

JUKI CORPORATION

2-11-1, Tsurumaki,
Tama-shi, Tokyo 206-8551, JAPAN

PHONE : (81)42-357-2341

FAX : (81)42-357-2379

Copyright © 2009-2012 JUKI CORPORATION.
All rights reserved throughout the world.
Reservados todos los derechos en todo el mundo.
Tous les droits sont réservés à travers le monde.
Tutti i diritti riservati in ogni paese del mondo.

