

List of main functions / specifications

Name	DX-4000QVP
Control System	Computer
Number of stitch patterns	368
Number of available fonts	4
Buttonhole	Automatic (sensor system) with clamping plate
Start / stop button	Green: Ready to start and / or while sewing Red: Not ready to start Orange: When the lock stitch button is pressed while the sewing machine is engaged in pattern sewing.
Maximum stitch speed	1,050sti / min
Auto thread trimming	Yes
Automatic needle threader	Automatic needle threader
Thread tension system	Automatic
Automatic lock stitch	Automatic lock stitch and thread trimming
Feed mechanism	Box Feed mechanism
JUKI Smart Feed (dual feed function)	Yes
Presser foot pressure adjustment	Stepless adjustment (digital)
Drop feed	Yes
Easy bobbin winding	Yes
Bobbin thread winder	Bobbin winder with independent motor
Quick bobbin preparation	Yes
Bobbin thread counter	No
Bobbin thread run-out sensor	Yes
Light	6 LED lights
Function to straight-line stitching	straight throat plate, straight feed dogs and straight presser foot
Micro-lifter	Presser foot pressure settings by dial
Free arm	Yes
Change in the length/wide of stitches	Dial system / LCD numerical display Stitch width: Max. 7mm Stitch length: Max. 5mm
Number of needle position (straight stitch/other than straight stitch)	37 / According to pattern
Pattern reverse	Up / Down and left / right
Twin needle sewing	Yes (Twin needle is option)
Elongation Pattern	Yes
Adjustable starting / reverse stitch speed	Yes
Needle up/down button	Yes
Low-speed inching sewing	Yes
Needle stop position switching	Yes
Presser foot pivot function	Yes
Save/call of patterns	10 patterns
Horizontal presser foot holder button	Yes
Height of lifting of presser foot (1 step / 2 steps)	Button system: 6 · 8 · 10mm / 12mm Lever system: 6mm / 12mm Knee-lifting Lever system: 6 · 8 · 10mm / 12mm
Lock mode	Yes
Operation guide	Displayed as animation and illustrations and text
Sewing machine cover	Soft cover with accessory storage
Auxiliary bed	Yes
Knee-lifting lever	Yes
Wide table	Yes
Foot controller	Yes (with separate foot switch)
Accessory box	Yes
Accessories	Standard presser foot (A) / Straight presser foot(S) / Zipper presser foot (B) / Overcasting presser foot (C) / Blind stitch presser foot (D) / Buttonhole presser foot (E) / Manual buttonhole presser foot (I) / Open toe presser foot (O) / Patchwork presser foot (P) / 1/4"guide foot (1/4) / Quilt presser foot (for the ruler) (Q) / Edge Sewing presser foot (R) / Rolled hemming presser foot / Zigzag free-motion quilting set (Quilt presser foot (zigzag type) / Presser foot holder setscrew / Adapter shank / Needle setscrew) / Straight throat plate / Straight feed dog / Bobbin (4) / Needle set HA X 1 # 11 (1); # 14 (1); # 16 (1); for knit # 11 (1) / Quilt guide / Auxiliary spool pin / T-shape screwdriver / Ripper / Cleaning brush / Spool cap (large) / Spool cap (Middle) / Spool cap (Small) / Foot Controller / Knee-lifting lever / Power cord / Wide table / Sewing machine cover / Quick Reference Guide / Accessory box
Dimensions	23.7"(W)×12.0"(H)×10.4"(D)
Arm size	12.0"(W)×4.7"(H) (305(W)×120(H)mm)
Weight	32.8lbs

DX-4000QVP



Feel Comfort and Power —
Professional Quality Quilting
and Sewing Machine



2-11-1, TSURUMAKI, TAMA-SHI, TOKYO
206-8551, JAPAN
<https://www.juki.co.jp>

JUKI ECO PRODUCTS This is an eco-friendly product which complies JUKI ECO PRODUCTS standards for protecting the environment.

●The sewing machine complies with the "JUKI Group Green Procurement Guidelines" on the use of hazardous substances, which is stricter than other restrictions, such as those of the RoHS Directive.

For details of JUKI PRODUCTS, refer to:
https://www.juki.co.jp/eco_e/index.html

*The RoHS Directive is an EU Directive limiting the use of 6 hazardous substances (lead, hexavalent chromium, mercury, cadmium, PBB and PBDE) in electrical and electronic equipment. The Juki Green Procurement Guideline is the voluntarily established criteria to eliminate not only the aforementioned six substances, but also other ones which also adversely affect the environment.

JUKI CORPORATION holds the rights to change technical specifications without prior notice. 2009(F)

DX-4000QVP **Kokochi**
Kokochi means "good feeling" in Japanese

User-focused operability



DX-4000QVP *Kokochi*



7" color touch panel can be operated like a smartphone

Just like on a smartphone or tablet, intuitively select and edit patterns, change various settings, and view operation videos. With only the most important and frequently used operations available, the layout and user friendliness of icons, etc., are revolutionary.



Light control function changes the color temperature of the light

NEW

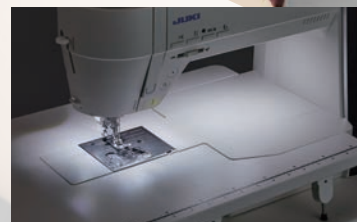
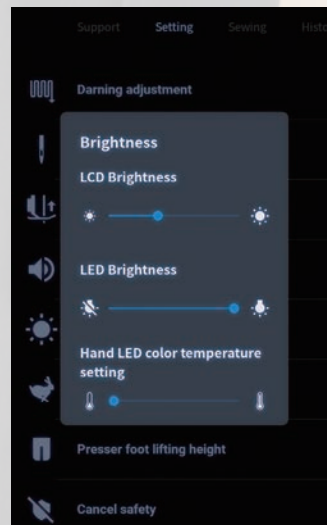

Daylight



Soft white

Adjust the color temperature of the bulb between daylight and soft white. This eliminates visibility difficulties with certain fabric and thread color combinations.

Notification before bobbin thread runs out

NEW

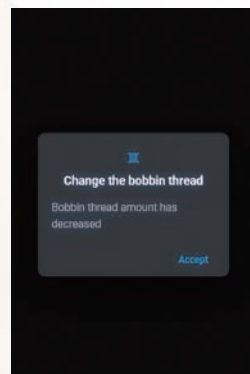

An optical sensor will notify you when the bobbin thread reaches a certain amount. Sew with confidence without worrying about the remaining amount of bobbin thread.

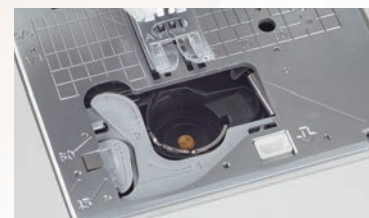

Have your favorite accessories always at hand

NEW



The auxiliary bed with accessory storage is the first among sewing machines with a 12" workspace. Keep your most often used accessories in their place and at your fingertips.

Visualization of adjustment values

NEW

Changes in adjustments can be visualized with animations.

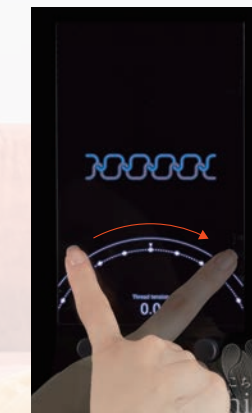

Adjust the thread tension by sliding your finger over the scale in the touch panel.

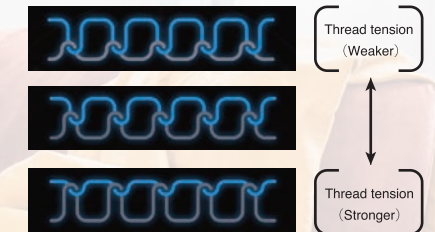

The animation changes according to the adjustment value.

Store recall stitch patterns

NEW

The last 10 stitches are stored in the history.

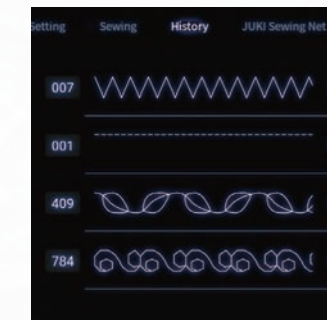

View illustrations of stitch patterns in the history to easily identify and select them with a single touch.

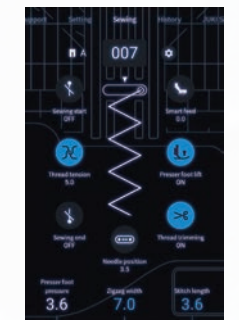

The settings that differ from the defaults are highlighted in blue.

Adjust the presser foot pressure with the easily accessible dial

NEW

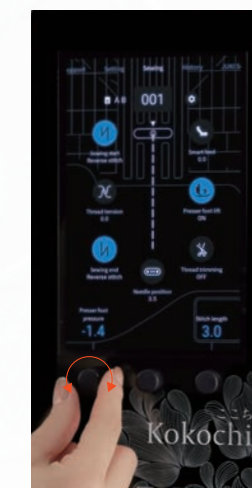

In addition to the popular stitch width and length adjustments, easily adjust the presser foot pressure with a dial below the touch panel. Being able to change the presser foot pressure while sewing allows you to immediately respond to stretched stitching and uneven feeding.



Before adjustment After adjustment

Sew fabrics like knit, fleece, neatly and more without stretching by adjusting the presser foot pressure.

Make sewing more pleasant



JUKI Smart Feed (built-in dual feed unit)



Using JUKI Smart Feed allows you to reduce uneven feeding and stretched stitching of thin fabric.



Feeding can be stabilized simply by lowering the unit.

Various presser foot lifting functions

Micro-lifter function

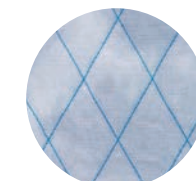
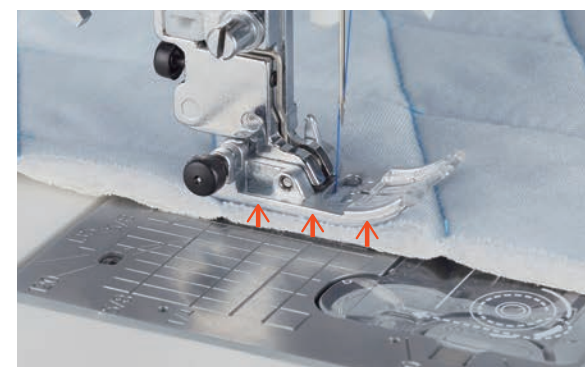

When micro-lifter function is used

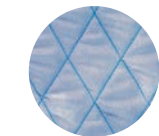

When micro-lifter function is not used

Using the presser foot pressure dial, you can raise the presser foot slightly to prevent uneven feeding and achieve a beautiful finish when sewing quilts, velvet, and other fabrics.

Automatic lowering of feed dog



The feed dog lowers automatically when the presser foot is raised to the extra lift position with the knee lifting lever. This prevents the fabric from getting caught on the feed dog and allows the fabric to be taken in and out smoothly.

Pivot function

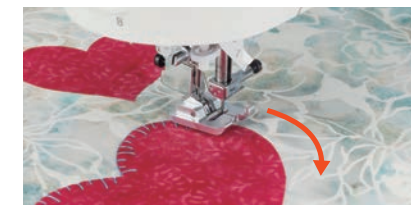

This allows you to easily change the sewing direction while leaving both hands on the fabric, for example, when sewing corners of appliques. (function to automatically raise the presser foot when sewing is stopped with the needle in the lower position)

Easily switch to straight stitch sewing conditions



Not only prevent the fabric from being pushed into the needle hole at the start of sewing, but realize operability that was only possible with a straight stitch sewing machine, such as sewing edges and sharp curves.

You can easily change the presser foot, feed dog and throat plate to straight stitch versions.



Straight throat plate



Straight feed dog

Beautiful buttonholes surpassing the quality of home sewing machines



Buttonhole sewing with clamping plate and sensor

This provides reliable feeding, even on thick fabrics and seams, and automatically corrects the left and right seam densities.

Adjustable cutting width for buttonholes

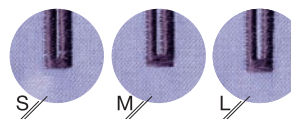

Since the cutting width can be changed, you can sew a buttonhole that matches not only the button size but also the button thickness.

Smooth and comfortable free-motion sewing

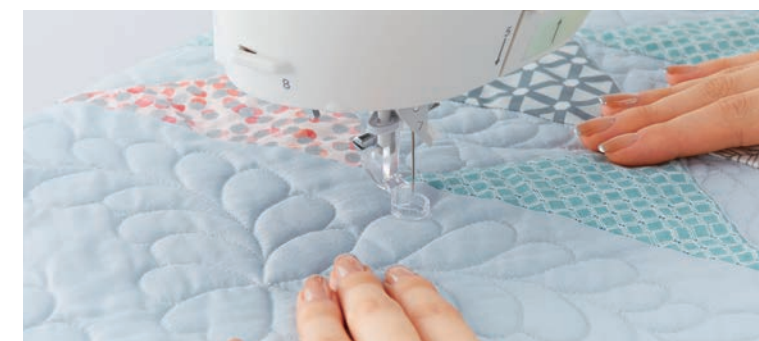

Transparent quilt presser foot makes the needle visible.



Since the feed dog can be lowered with the push of a button, you can easily set up the machine for free-motion sewing.

Zigzag free-motion quilting set
With these, you can enjoy free motion quilting of zigzag sewing.

Use the included quilt presser foot for free-motion quilting with a ruler (ruler work).* The ruler is an optional accessory.

Enjoy more variations and applications with tapering

NEW

Increased ranges of the angle and direction settings have expanded the possibilities for sewing tapering.

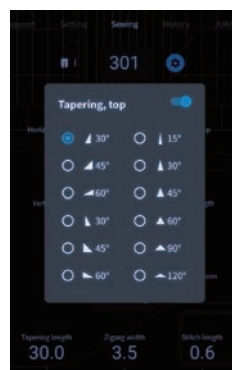

You can select the angle and direction for the beginning and end of tapering.

You can set a stitch length in advance or store the length of the stitches that were sewn.

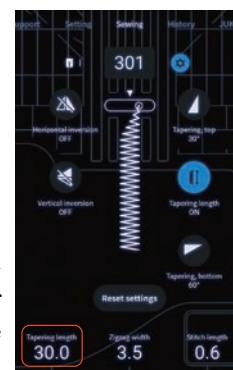

By using the memory and inversion functions, star-shaped appliques can be beautifully finished.

Expanded custom sewing

More convenience with 7" LCD and animations!

Browse the Internet or Watch Videos from Your Machine!

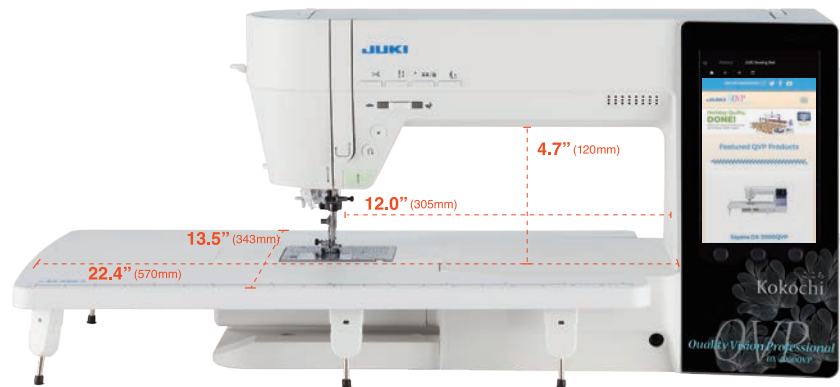

Connect to the internet to access JUKI Sewing Net from your sewing machine! From the Sewing Net, you can access JUKI's homepage where you may view projects, product information, and more. In addition, you can watch instructional videos of projects and/or sewing machine from JUKI's YouTube channel.

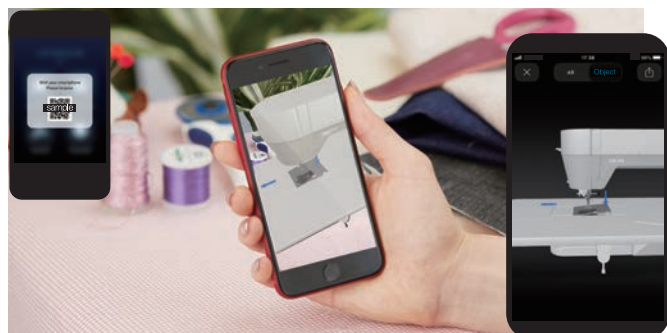

You can view an instructional video on your smartphone by scanning the QR code of the operating procedure that you want to view.



Select the title of the operating procedure that you want to view and follow the step-by-step instructions show in animated video.

Easily combine and recall patterns

Smartphone-like touch panel operations make it very easy to combine one-point patterns and characters. You can also recall (up to 10) previously created patterns after viewing them on the screen.



Create multiple variations from a single pattern, such as combining vertical and horizontal inversions.

Stitch Patterns (368)

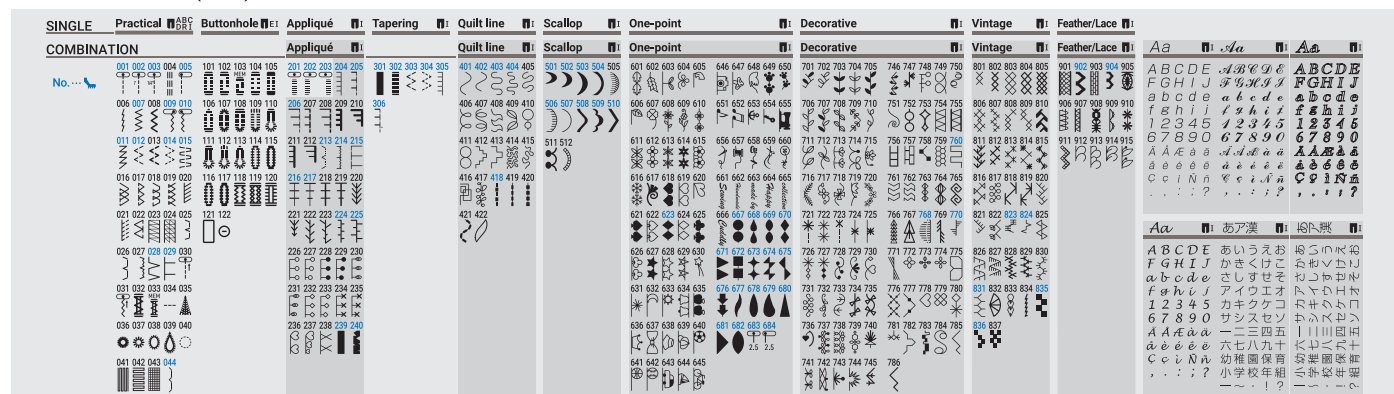

More fun with optional items! Easy to use with included accessories!

Optional accessories

Easy positioning at the beginning of sewing with the cross LED pointer

LED pointer



With the LED pointer, you can start sewing without lowering the needle to check the sewing start position. You can also attach a borescope camera instead of the LED pointer.

Part No.40247205

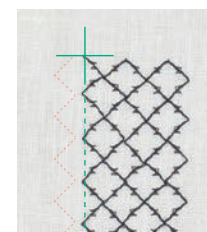

Expand your creativity with the LED pointer as a guide when aligning rows of patterns for sewing.



Easily share images and videos you are sewing to social media
*Please purchase a commercially available borescope camera.

Mounting base



The mounting base allows you to attach the LED pointer, scope, and magnifying lens attachment to the sewing machine.

Part No.40247204

Thick thread decoration



Enjoy more three-dimensional decorations with thick threads or ribbons.



Dedicated hook for thick thread decoration

It is used when decorative sewing is performed with bobbin thread using thick thread or ribbon. Wrap the thread you want to decorate around the bobbin and draw a pattern with pattern stitching or free motion.

Part No.40247203

Other optional accessories



Thread stand(for two spools)

Part No.40245194

Put two large spools.



Magnifier(Flip-up type)

Part No.40247079

Use the mounting base. (Part No.40247204)

Use as a magnifying glass to enlarge the needle area. When not in use, you can move it out of the way.



Quilting presser foot (open type)

Part No.40224355

Use the adapter shank.

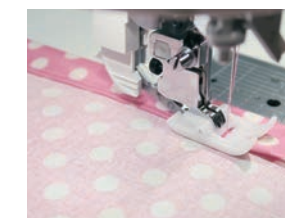

Smooth presser foot (for JSF)

Part No.40248701

The smooth presser foot that can be used for JUKI Smart Feed. Used for difficult materials.

Included accessories

Auxiliary box



Store all accessories such as presser feet and bobbins.

Electric knee lifting lever

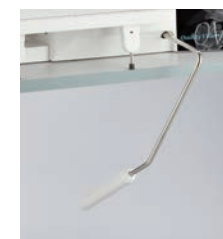

This highly responsive lever allows the presser foot to be moved up and down with very little force and without taking your hands off the fabric.

Foot controller (with independent foot switch functions)



The foot switch can be attached to either the left or right side of the pedal. Any one of seven switch operations can be assigned to the foot switch.